

VERSION 3.03



INSTRUCTION MANUAL

MODEL: WR14 & WR50-12/13
WINDING RESISTANCE METERS



WR14: 15A WINDING RESISTANCE METER



WR50-12/13: 50A WINDING RESISTANCE METER

RAYTECH USA, INC.

118 SOUTH 2ND STREET, PERKASIE, PA 18944 USA
T: 267 404 2676 | F: 267 404 2685 | WWW.RAYTECHUSA.COM



TABLE OF CONTENTS

Safety Precautions	5
Unpacking	6
WR50.....	6
WR14.....	7
Introduction.....	8
General	8
Advantages & Features	9
System Details.....	9
System Check.....	9
Limitations of Winding Resistance Testing	9
Discharging the Transformer Windings	10
Low Resistance Testing.....	10
Quick Start Guide	11
Instrument Operation – Profiles Deactivated.....	11
Instrument Operation – Using Profiles	12
Selection of the Proper Current Range	14
Connection to the Test Object.....	14
Single Phase Transformer, Vector Group 0.....	15
Three Phase Transformer, $\Delta - \Delta$ Vector Group 0	16
Three Phase Transformer $\Delta - Y$, One LV Winding	17
Three Phase Transformer $\Delta - Y$, Two LV Winding	18
Operation Elements for field units.....	19
WR50 Front Panel Overview:.....	19
WR50 Control Elements and Connections.....	19
Fuse, Mains Input and Switch.....	19
Emergency Stop	19
Thermal Printer	19
Safety Indicator	20
Display With Touch Panel.....	20
Potential Receptacle	20
Current Receptacle	20
External.....	20
Ground Terminal.....	20
Temperature Receptacle	20
Interface	20
WR14 Front Panel overview.....	21

WR14 Control Elements and Connections.....	21
Charge Indicator and Main Switch.....	21
Interface.....	21
Thermal Printer.....	21
Display With Touch Panel.....	21
Ground Terminal.....	22
External.....	22
Temperature Receptacle.....	22
Potential Receptacle.....	22
current Receptacle.....	22
Safety Indicator.....	22
Emergency Stop.....	22
Mains Input.....	22
Operating Menu.....	23
Menu Structure Without Using Profiles.....	25
Menu Structure Using Profiles.....	26
Introduction to Transformer Profiles and Data Structure.....	27
Main Menu.....	29
Main Menu Screen.....	29
Start.....	31
Store.....	31
Stop.....	31
Demag.....	32
Setup.....	33
Results.....	52
Profile.....	56
Options.....	64
Temperature Measurement.....	64
Heat Run Test Software.....	65
Introduction.....	65
Measurement with Interval Mode for HRT.....	66
Analyzing the HRT Results.....	68
Battery Option - WR14R.....	73
Cable Extensions for WR100R.....	75
10M Cable Extension Set for the WR100-12R.....	75
10M Cable Extension Set for the WR100-13R.....	76
Cable Extensions for WR50R.....	77



10M Cable Extension Set for the WR50-12R	77
10M Cable Extension Set for the WR50-13R	78
10M Cable Extension Set for the WR14-R	79
Technical Specifications	80
WR50	80
WR14	82
Interfaces	84
Hardware	84
RS 232	84
USB	84
Extern	85
Appendix	88
Raytech T-Base Pro	89
Description	89
Application Example	90
Concept of T-Base Pro	92
Components of T-Base Pro	92
T-Base Pro – Totally FREE	92
Create your Add-On with T-Base SDK	92
T-Base Pro Remote Option for Raytech Devices	93
Proprietary Add-On: Sequence	93
Proprietary Add-On: Remote I/O to External Software	93
Graphical User Interface	94
USB Driver for T-Base Pro	95
Software Development Kit (SDK)	96
Service Mode	97
Calibrate Touchscreen	97
Show Ground Warning	98
CSV Separator	99
Raytech USB Driver for T-Base	100
ActiveSync for Toolbox	100
Command Syntax	101
Serial Interface	101
USB Interface	102
USB Printer Info	103
Printer Requirements	103
Driver	103

Interface.....	103
Suggested Printers	103
Measuring High- and Low- Voltage Sides in Series	104
Measuring with 2 WR Meters at the Same Time	107
Demagnetizing	109
Energizing Magnetized Transformers	109
Conclusion.....	109
Consequences of Energizing a Magnetized Transformer	109
Procedure for Eliminating the Magnetized State of a Transformer	110
Parameters for Demagnetizing.....	110
Multiplexer	111
Error Messages.....	112
Trouble Shooting.....	114
Warranty Conditions.....	116
Limitation of Warranty.....	117
Arbitration	117
Contact Information:.....	118



SAFETY PRECAUTIONS

The following safety precautions must be observed during all phases of operation, service and repair of this instrument. By purchasing this equipment, the purchaser assumes all liability for the operation and use of this equipment. The intended use of the instrument, its design and manufacture, is to be conducted within the precautions or other specific warnings located within this manual. Failure to comply with these precautions and other specific warnings violates safety standards of design, manufacture, and intended use. Raytech and its affiliates assume no liability for the operation and use of this equipment.

SAFE OPERATION:

Only qualified, knowledgeable persons should be permitted or attempt to operate this test equipment. All test personnel should fully familiarize themselves with the correct application and operation of this and all test equipment prior to operation. Persons directly and indirectly engaged in the operation of this test equipment should keep clear of all high voltage apparatus while conducting tests and measurements.

BEFORE APPLYING POWER:

Read this manual carefully before operating the system. The WR14 is battery operated, the WR50-12 and the WR50-13 are line operated. They operate from a wide range of power input from 90 to 264Vac and 47...63Hz with automatic ranging.

GROUND THE INSTRUMENT:

The power cord supplied with the equipment must be connected an electrical receptacle with an electrically grounded terminal (Earthed Ground). To minimize shock hazard, the Ground Terminal on the instrument must be properly connected to an Earth grounded point. In many cases, the quality of the safety ground terminal provided by the power cord does not fulfil the safety requirements.

Non-grounded instruments are dangerous and may cause Personnel and instrument damage.

KEEP AWAY FROM LIVE CIRCUITS:

Operating personnel must not remove instrument covers. Component replacement and internal adjustments must be made by qualified service personnel. Do not replace components with the power cable connected. To avoid injuries, always disconnect power, discharge circuits, and remove external voltage sources before touching components.



WARNING!

Never connect the instrument to an energized transformer.

DO NOT OPERATE IN AN EXPLOSIVE ATMOSPHERE:

Do not operate the instrument in the presence of flammable gases or fumes.

DO NOT SUBSTITUTE PARTS OR MODIFY INSTRUMENT:

Because of the danger of introducing additional hazards, do not install substitute parts or perform any unauthorized modification to the instrument. Return the instrument to a Raytech service department for service to ensure proper operation and that safety features are maintained.

Instruments, which appear damaged or defective, should be made inoperative and secured against unintended operation until they can be repaired by qualified service personnel.

UNPACKING

Unpack your new instrument and check to see that you have the following standard items:

WR50



Instrument



Cable Bag



Current Cables



Jumper Cable(s)



Power Cord



5 Printer Refill Rolls



Potential Cables: Channel 1



Potential Cables: Channel 2



Potential Cables: Channel 3
(WR50-13 only)



USB Memory Stick



Instruction Manual

If any of the above items are missing or damaged, contact your local representative or Raytech USA immediately. Optional test leads may be ordered (other than shown).



WR14



Instrument



Cable Bag



Current Cables



Jumper Cable(s)



Power Cord



5 Printer Refill Rolls



Potential Cables: Channel 1



Potential Cables: Channel 2



USB Memory Stick



Instruction Manual

If any of the above items are missing or damaged, contact your local representative or Raytech USA immediately. Optional test leads may be ordered (other than shown).

INTRODUCTION

GENERAL

Raytech Digital Winding Resistance meters are an enhanced version winding resistance system with the most advanced demagnetizing circuit. They are designed for a high degree of accuracy for the measurement of very low resistance of inductive loads.

Ease of use: This intelligent system has an easy to use operation screen which allows quick selection of the current level to be measured. This system incorporates a touchscreen which allows the user easy access to change or activate a feature.

Impressive Accuracy: The WR series of instruments have high precision, fully automatic, multi-microprocessor based architecture. These systems are designed for highly accurate readings on-site with laboratory precision.

Unique Measuring Technique: This newly designed technique of measurement incorporates a high precision measurement circuit, a unique power source and the fastest discharge unit on market. Extensive filtering and high precision standards are used within the test system. The WR50 series is capable of precision measurements up to 50A (WR14: 15A).

Operation: The WR series of instruments apply a present current level, selected by the user, from 0.025A to 100A. The 50V¹ power source quickly charges the load and the results of the test are displayed within a few seconds automatically. The results are reported on the easy-to-read, color LCD display and can be stored or printed.

Compact Design: The WR50 and the WR14 series of instruments are available in their own rugged waterproof field cases.



NOTE!

The WR field case is a waterproof design. A pressure regulator activates when the case is opened to compensate for atmospheric pressure changes.

The WR series (including the WR100) is also available for 19" rack-mount installation.

Advanced Protection: Upon powering on, the system initializes itself with a self-calibrating, circuit checking sequence. If any problems are detected during this initialization period, or during operation, the operator is immediately notified. The system constantly monitors the condition of the transformer under test. The WR series of instruments have extensive protection built in to the circuitry. This is one of the many reasons we can extend our warranty to 5 years.

Simple Maintenance: There is no maintenance required. There is no calibration procedure (no potentiometers to turn). This is due to the utilization of high precision components in the design.

¹ WR14: 30V



ADVANTAGES & FEATURES

- Highest Accuracy and Precision of any high current test system
- Automatic measurements of Low Resistance from $0.00\mu\Omega$... $100k\Omega$
- Demagnetizing Circuit (Advanced design)
- Microprocessor based system with internal storage for over 10,000 test results
- Data exchange via USB-Key
- Storage and Printing of test results while the test system is measuring
- Complete automatic calibration system and system diagnostics
- Temperature channels with automatic resistance correction
- Standard USB 2.0 & RS 232 (serial) Interface
- Pure filtered DC Power source for the highest accuracy readings
- Automatic, high efficiency cooling system to dissipate internal temperatures
- Automatic shut off for over-temperature condition
- Color LCD with backlighting and touch screen
- Panel mounted Emergency Stop Switch
- Mounted in rugged case for field testing
- Fastest discharge time in the market
- 5 Year standard warranty

SYSTEM DETAILS

SYSTEM CHECK

The instruments are line operated². The systems are designed to be used with AC Voltage power sources between 90 to 264VAC 47...63Hz. The systems perform a self-check each time that they are powered on. The User should always visually inspect all connectors, cables and devices to be measured to avoid any safety issues.

LIMITATIONS OF WINDING RESISTANCE TESTING

In general, there are no limitations on testing low or high inductive windings of transformers. The test systems are specially designed to test all transformer windings.

² The WR14 is battery operated in addition to mains power.

DISCHARGING THE TRANSFORMER WINDINGS

The WR systems are specialized systems designed to measure Transformer windings. These systems are equipped with heavy-duty discharge circuits that are very unique in design.

The internal discharge circuit dissipates the stored energy in the transformer windings with a “Constant Power Discharge Circuit” that is unique to all transformer winding test systems.

That is the reason why Raytech systems can discharge transformers more than 10 times faster than any other system on the market.

If a cable happens to fall off during test, the system will STILL discharge the test object safely with the automatic Constant Power Discharge Circuit.

The Potential Test Leads are part of the safety circuit and have the ability to discharge a transformer should one of the current leads become detached.



WARNING!

Do not use potential cables with smaller gauge cables (Channel 1, 2, or 3) than the original Raytech cables supplied!

LOW RESISTANCE TESTING

The WR series of test instruments utilize a 4 wire measuring technique for each Channel. The points where the potential leads are connected determine the resistance reading.

The test set employs a very simple principle of Ohm's law:

$$R = \frac{U}{I}$$

where

R = Resistance

U = Voltage

I = Current



QUICK START GUIDE

INSTRUMENT OPERATION – PROFILES DEACTIVATED³

1. Power on the instrument. Press Setup.

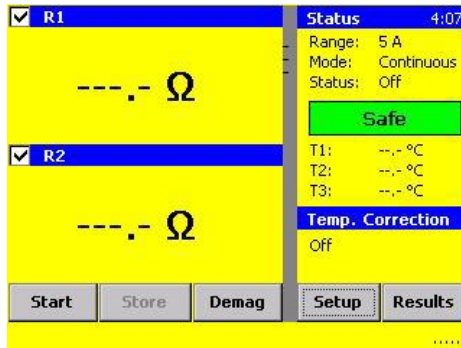

2. Select the Test Current, press Range or Setup/Range. Press OK.

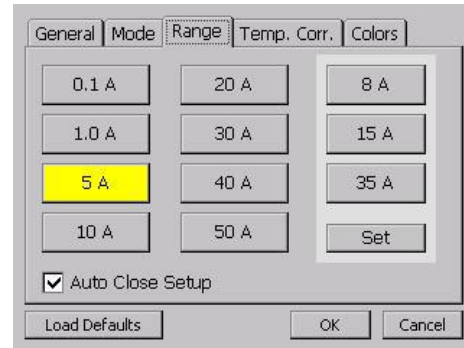

3. Press the Start button.

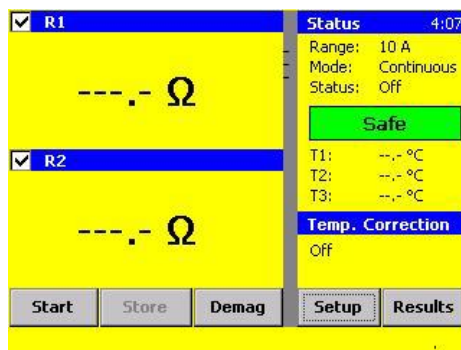

4. The results will be displayed. Press Stop.

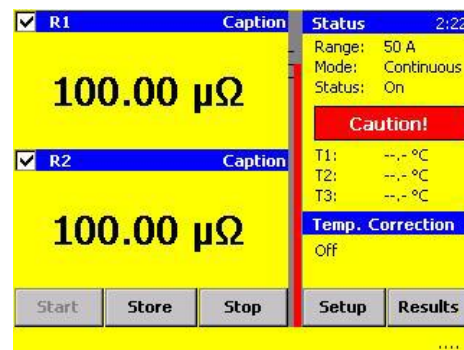

5. The Safe indicator will show green.

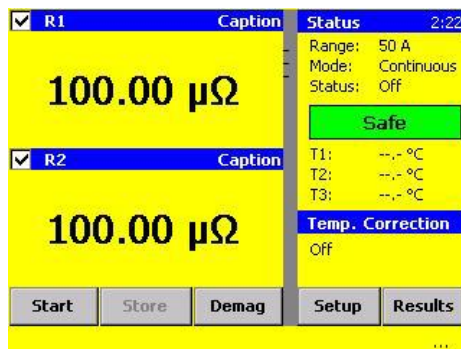

WARNING!

Wait until the green light shows “Safe” before handling the cables.

For examples of transformer connections, see the next pages.

³ The checkbox for “Use Profiles” is not selected in the Setup under General.

INSTRUMENT OPERATION – USING PROFILES

1. Power on the instrument. Press Setup.

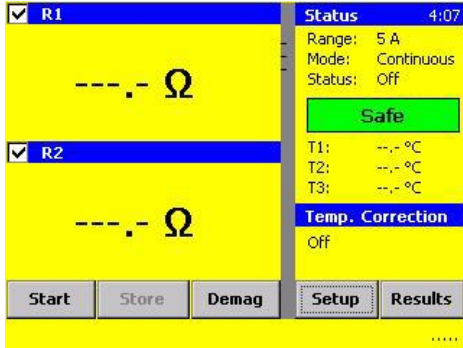

2. On the General Tab, check “Use Profiles” and touch “OK.”

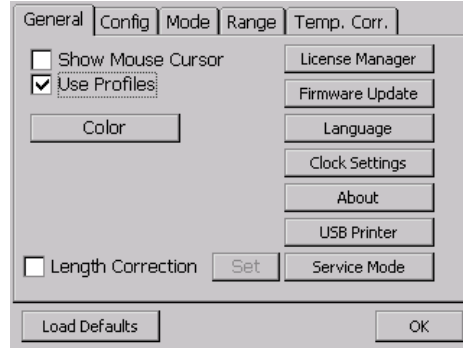

3. Touch “Profile.”

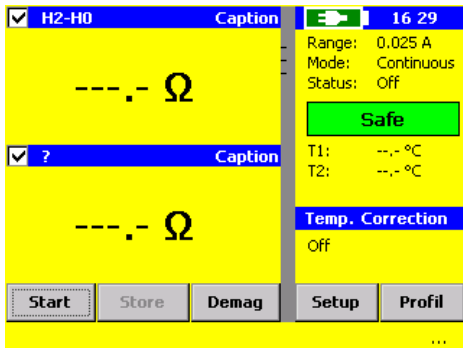

4. Touch “New.”

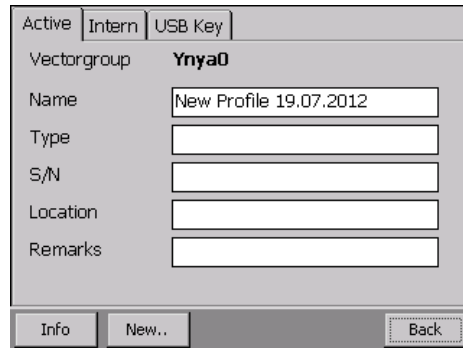

5. Touch “New Transformer.”

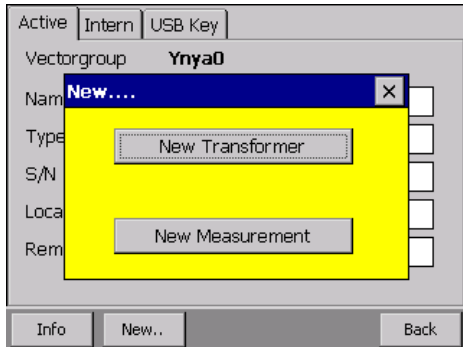

6. Define new Transformer parameters by selecting the symbols at the bottom of the screen, then touch “Go.”

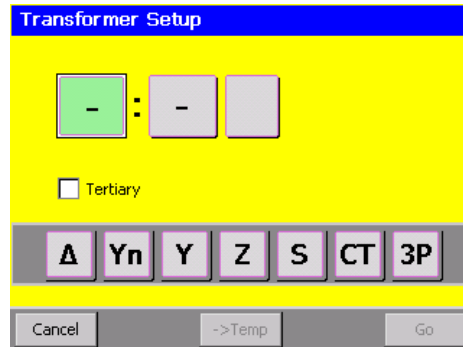



7. Enter additional Data and touch “Back.”

8. Touch “Caption” or the blue area above the Result to change.

9. Choose a Caption.

10. ... and touch “OK.”

11. Start a measurement as usual.



WARNING!

Wait until the green light shows “Safe” before handling the cables.

For examples of transformer connections, see the next pages.

SELECTION OF THE PROPER CURRENT RANGE

Ensure that the test current does not exceed 10% of the rated winding current. This could cause erroneous reading due to heating in the winding.

CONNECTION TO THE TEST OBJECT

Always check the winding schematic on the nameplate and trace the current path through the windings.

You can save time if you measure the high voltage side in series with the low voltage side from the same magnetic core. Because there are more turns on the high voltage side, you'll reach saturation flux in the core much faster. This helps to stabilize the measurement and saves time.

The potential leads must be connected in between the current leads. Do not clip the potential leads to the current leads.



SINGLE PHASE TRANSFORMER, VECTOR GROUP 0

Measurement of HV and LV Winding

<input checked="" type="checkbox"/> R1	0.7012 mΩ	Status 11:01
<input checked="" type="checkbox"/> R2	0.9584 mΩ	Range: 10 A
		Mode: Continuous
		Status: On
		Caution!
		T1: --.- °C
		T2: --.- °C
		T3: --.- °C
		Temp. Correction
		Off
Start	Store	Stop
		Setup Results

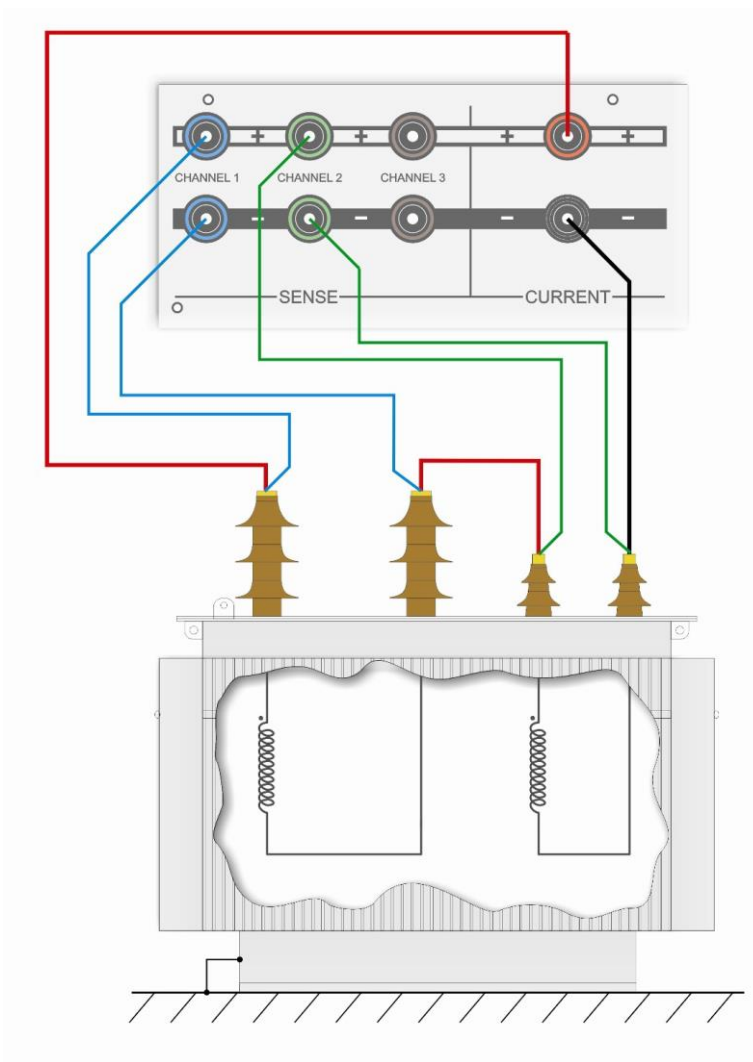

THREE PHASE TRANSFORMER, Δ – Δ VECTOR GROUP 0

Measurement of HV and LV Winding

<input checked="" type="checkbox"/> R1	0.7012 mΩ	Status 11:01
<input checked="" type="checkbox"/> R2	0.9584 mΩ	Range: 10 A
		Mode: Continuous
		Status: On
		Caution!
		T1: --.- °C
		T2: --.- °C
		T3: --.- °C
		Temp. Correction
		Off
Start	Store	Stop
		Setup Results

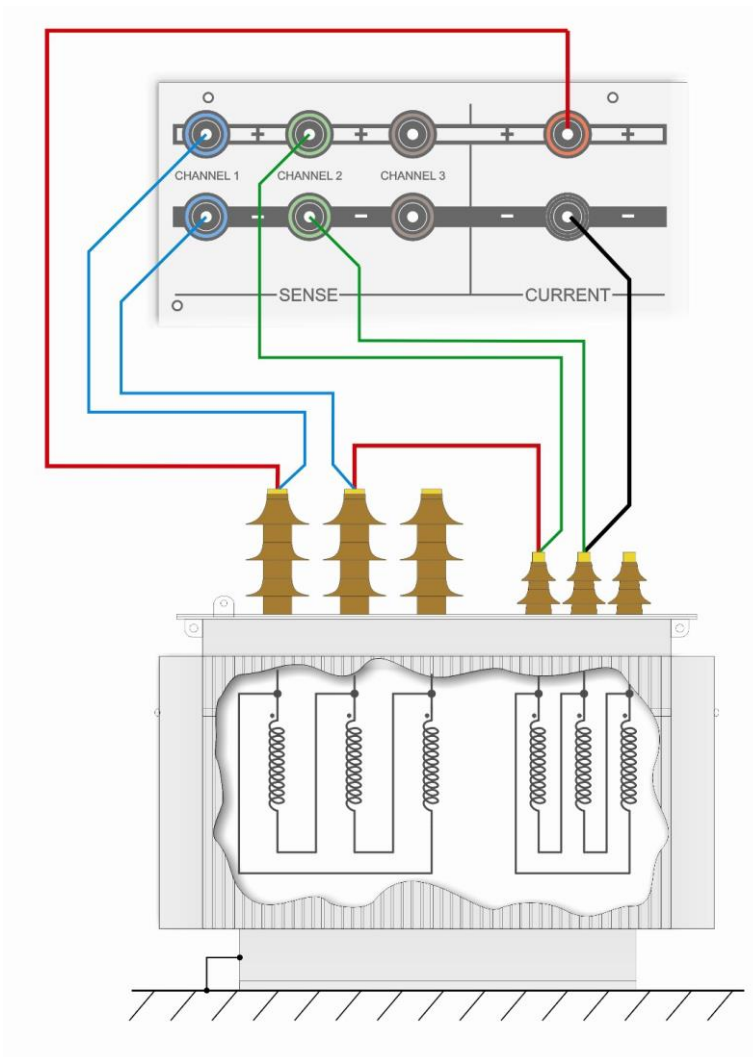



THREE PHASE TRANSFORMER Δ – Y, ONE LV WINDING

Measurement of one LV Winding

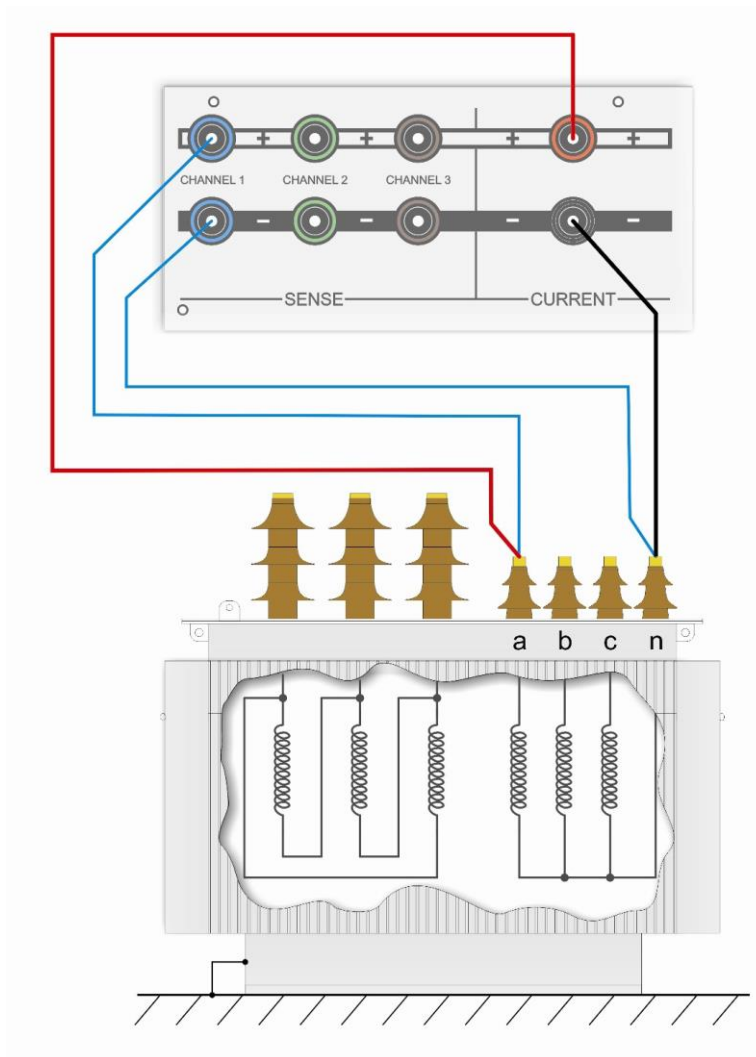
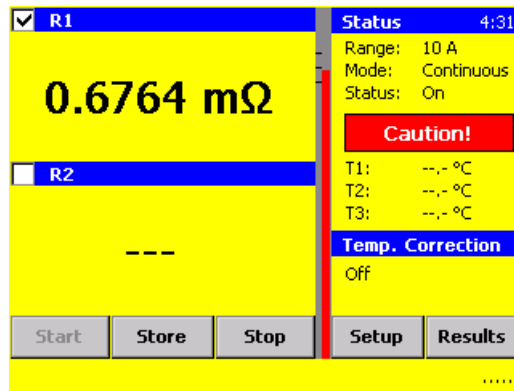

THREE PHASE TRANSFORMER Δ – Y, TWO LV WINDING

Measurement of two LV Winding

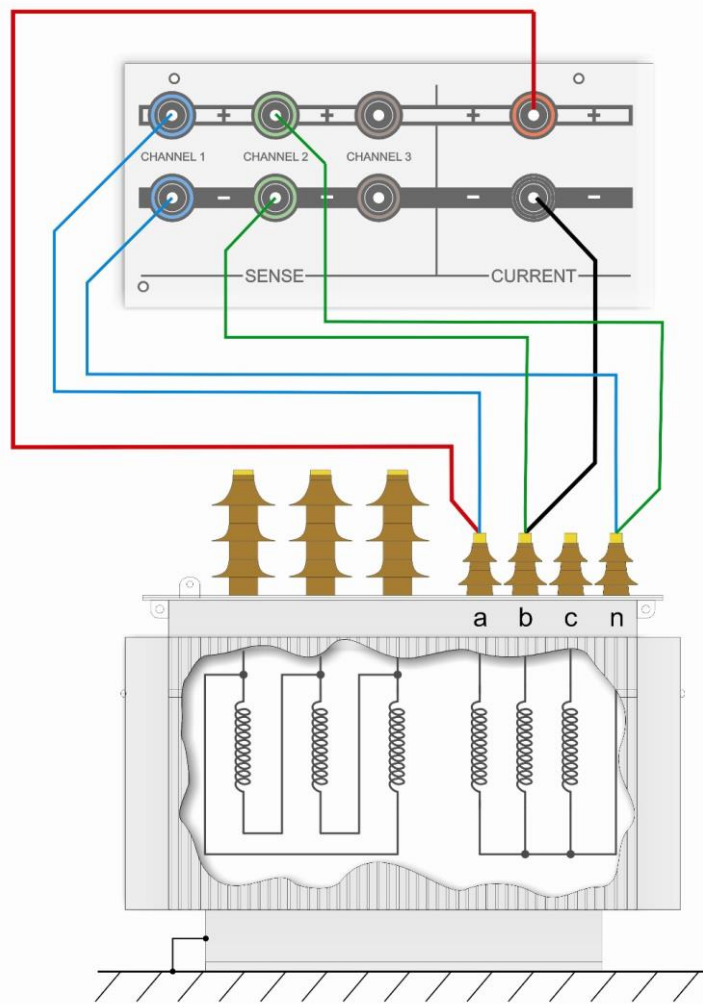
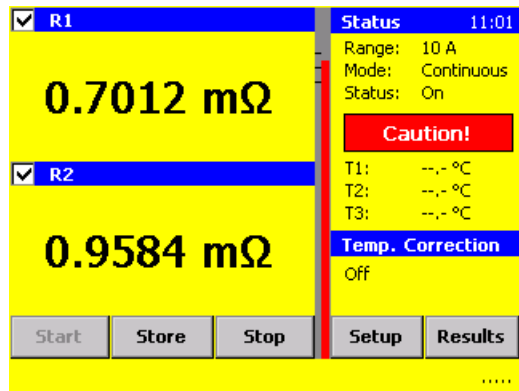



OPERATION ELEMENTS FOR FIELD UNITS

WR50⁴ FRONT PANEL OVERVIEW:

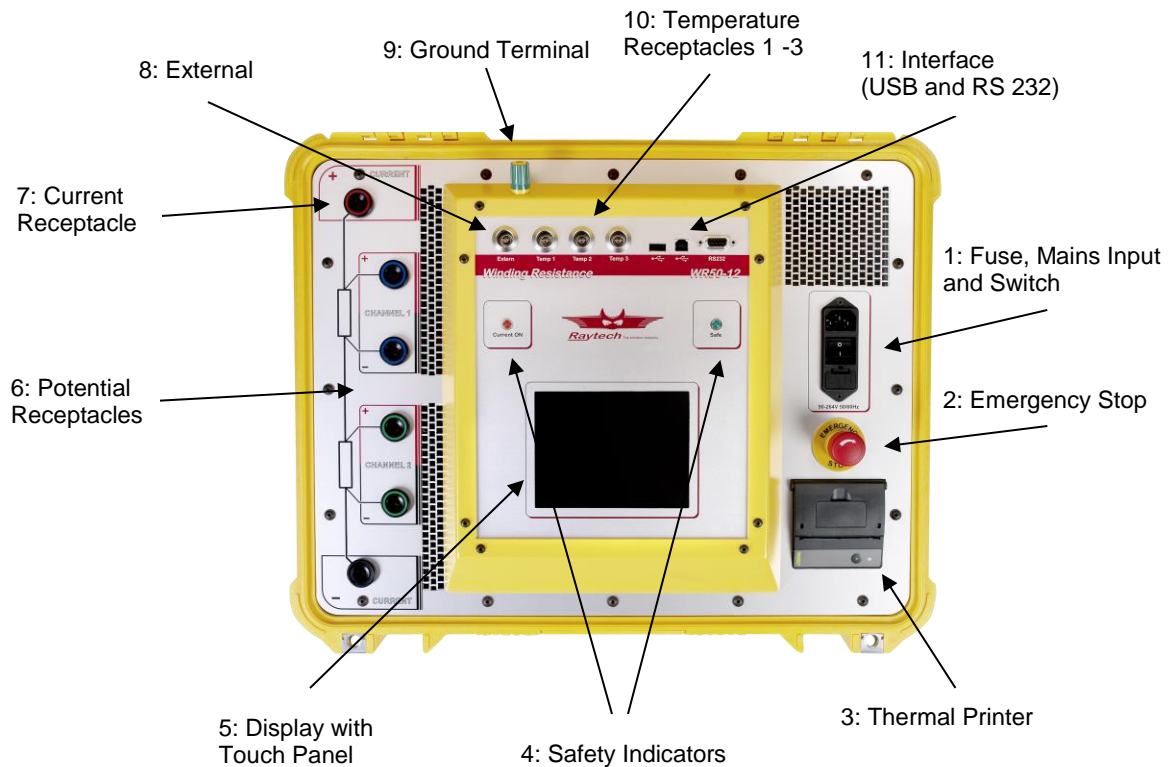

WR50 CONTROL ELEMENTS AND CONNECTIONS

FUSE, MAINS INPUT AND SWITCH

A 16A fuse (slow blow) protects the device. Use only the correct fuse type to replace it.

EMERGENCY STOP

Press to Stop. The measurement will stop and immediately begin to discharge the transformer. Turn clockwise to release. The device will remain in a safe mode state.

THERMAL PRINTER

Allows the user to quickly get results on paper by using the built-in thermal printer. The printer uses thermal heat transfer technology. Therefore, there are no ink cartridges required or printer heads. Special thermal paper is required for the printer to operate properly.

⁴ This illustrates a WR50-12 (2 channel instrument), the WR50-13 has a 3rd channel.

SAFETY INDICATOR

Green Light on: System is in safe standby mode. Ready for handling test leads and connections.
Red Light on: Unsafe mode! Do NOT remove any cables. There is current flowing and voltage on the test leads. System is testing.



WARNING!

The transformer is not discharged!

DISPLAY WITH TOUCH PANEL

The instrument can be easily manipulated and fully controlled by the touch screen panel. If preferred, an external mouse can be connected to the USB Port for system control.

POTENTIAL RECEPTACLE

Connect positive (+) and negative (-) potential cables for each channel to the test object (Channel 3 only on WR50-13).

CURRENT RECEPTACLE

Connect positive (+) and negative (-) current cables for each channel to the test object.

EXTERNAL

This port is used for an external warning device. See the chapter on interfaces for more details.

GROUND TERMINAL

Use this terminal to connect an additional ground line even if your mains Power cable (Mains) provides an Earth ground line. Also, use it even if you are not sure that the local installation Earth ground is a low resistive ground.

TEMPERATURE RECEPTACLE

These three (3) receptacles are for the external temperature probes (Optional accessory part number: 2021N-26001).

INTERFACE

RS 232 and USB 2.0 (1 Host, 1 Device). See “Interfaces” on page 84 for more details.



WR14 FRONT PANEL OVERVIEW

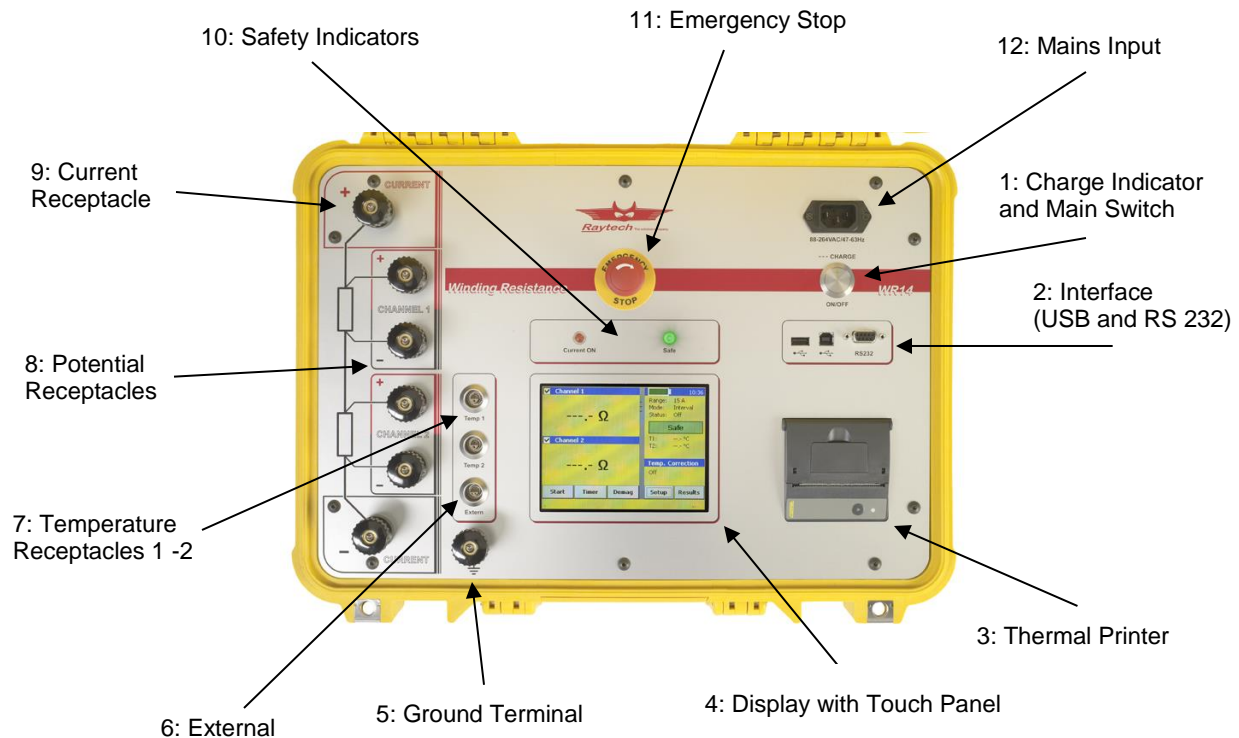

WR14 CONTROL ELEMENTS AND CONNECTIONS

CHARGE INDICATOR AND MAIN SWITCH

This LED light will blink when charging the battery, even when the WR14 is powered off.

When the instrument is powered on, the LED light will remain constant and will blink if a power cord is attached and charging the internal battery.

Press to power the WR14 on and off.

INTERFACE

RS 232 and USB 2.0 (1 Host, 1 Device). See “Interfaces” on page 84 for more details.

THERMAL PRINTER

Allows the user to quickly get results on paper by using the built-in thermal printer. The printer uses thermal heat transfer technology. Therefore, there are no ink cartridges required or printer heads. Special thermal paper is required for the printer to operate properly.

DISPLAY WITH TOUCH PANEL

The instrument can be easily manipulated and fully controlled by the touch screen panel. If preferred, an external mouse can be connected to the USB Port for system control.

GROUND TERMINAL

Use this terminal to connect an additional ground line even if your mains Power cable (Mains) provides an Earth ground line. Also, use it even if you are not sure that the local installation Earth ground is a low resistive ground.

EXTERNAL

This port is used for an external warning device. See the chapter on interfaces for more details.

TEMPERATURE RECEPTACLE

These two (2) receptacles are for the external temperature probes (Optional accessory part number: 2021N-26001).

POTENTIAL RECEPTACLE

Connect positive (+) and negative (-) potential cables for each channel to the test object.

CURRENT RECEPTACLE

Connect positive (+) and negative (-) current cables for each channel to the test object.

SAFETY INDICATOR

Green Light on: System is in safe standby mode. Ready for handling test leads and connections.
Red Light on: Unsafe mode! Do NOT remove any cables. There is current flowing and voltage on the test leads. System is testing.



WARNING!

The transformer is not discharged!

EMERGENCY STOP

Press to Stop. The measurement will stop and immediately begin to discharge the transformer. Turn clockwise to release. The device will remain in a safe mode state.

MAINS INPUT

Connect a power cord to the Mains Input (88 to 264 V / 47 to 63 Hz).



OPERATING MENU

The instrument software is straight forward and easy to set up and operate. With a few key strokes and selections on the test screen, measurements can be started. See the Quick Start Guide, on page 11. Even if the Profiles Mode is selected, measurements can be made quickly.

To switch between the Standard mode and the Profiles mode, press "Setup" and select the tab "General." The following screen will appear where you can enable "Use Profiles:"

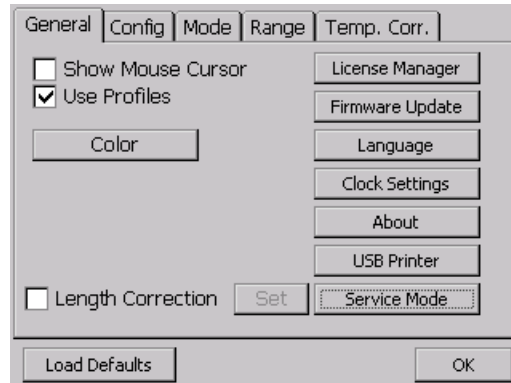

The difference between Standard mode and the Use Profiles mode is how you ultimately store your result.

Standard mode is for acquiring the measurement values of Resistance organized by date and time, and the "Results" button appears on the main measurement screen as shown below. This is an indication that the Standard mode is selected.

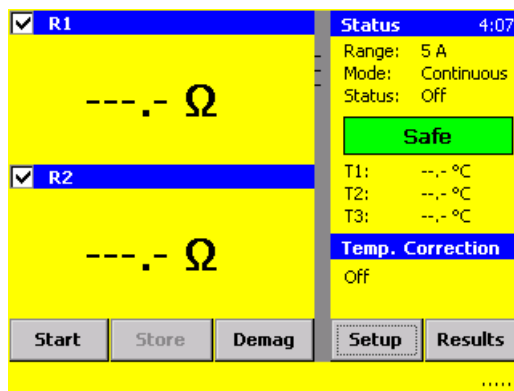

For more details, see "Menu Structure Without Using Profiles" on page 25.

Profiles mode is for assigning the results to a transformer Profile. When Profiles mode is selected, the main measurement screen will display "Profile" in the lower right of the main screen instead of "Results."

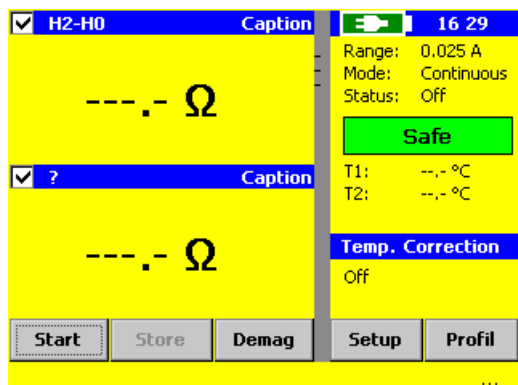

For more details, see "Menu Structure Using Profiles" on page 26.



MENU STRUCTURE WITHOUT USING PROFILES

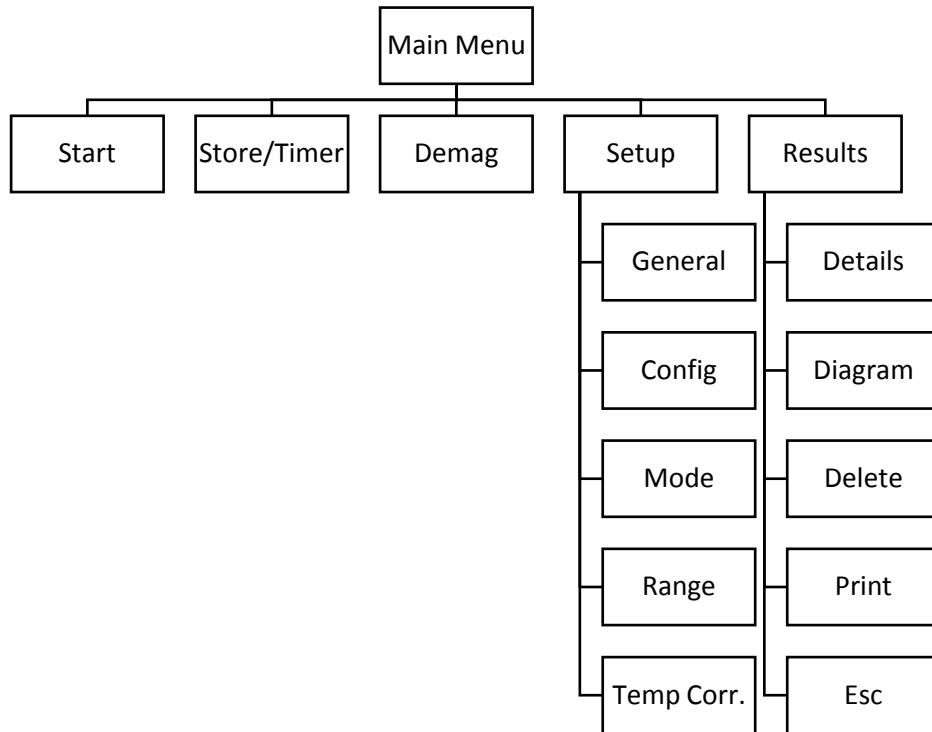

To work without using the Profiles mode, turn off the Profiles mode in the Setup menu by unchecking the check box shown in “Operating Menu” on page 23.

The results will be simply organized and saved by date and time without any transformer information (Standard mode).

MENU STRUCTURE USING PROFILES

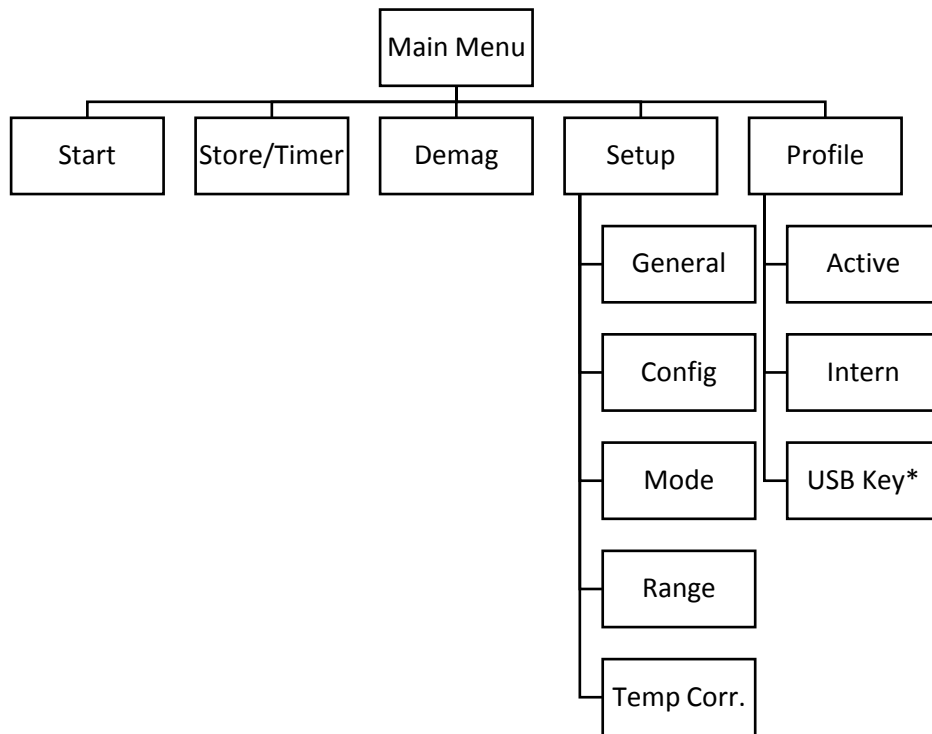

*Only available if a USB Key is connected to the instrument.

To use the Profiles mode, as described in this chapter, turn it on in the Setup menu by selecting the check box shown in “Operating Menu” on page 24.



INTRODUCTION TO TRANSFORMER PROFILES AND DATA STRUCTURE

There are many instruments that measure and offer the possibility to store the measured value. This is a very useful feature which saves time and eliminates the possibility of errors of writing down values by the operator. However, the measured data must be handled and organized in a proper manner to be useful. Mishandling data collected by multiple operators and multiple instruments could easily introduce errors and mistakes within the data sets.

The WR instruments offer another very powerful software tool for organizing and handling transformers which are tested time and again. This allows building a history of a transformer.

Once a transformer record, or a Profile, is created, then many measurements can be directly attached to this record file. Manually logging, storing and sorting measurements will not be necessary once a Profile is created.

The Profile record of a transformer contains the general header information and an attached result contains the measurements of the transformer. Or to define it more exactly:

A transformer / profile contains:

- Number of winding systems
- Type of winding systems (Configuration)
- Rated voltages (primary, secondary, tertiary)
- Name plate info (name, serial number, location, manufacturer, type and remarks)

A measurement contains:

- Measured results of all phases
- Date and time
- Operator name

Start by creating a new transformer Profile. Then measurements are made and stored (attached to the Profile). In this case, the profile and the actual measurement will be stored together.

Or you may load an existing transformer Profile then do the required measurements and store them. In this case, the new measurement will be attached (stored) with the loaded or active transformer Profile.

This is illustrated in the following scenario:

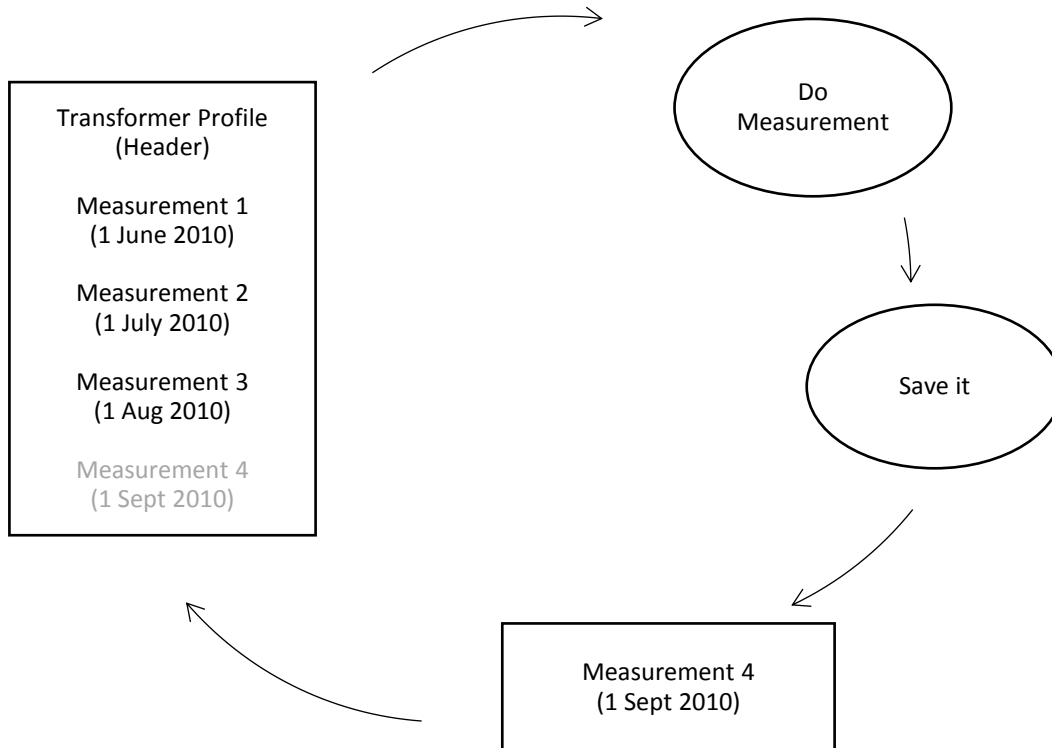

This shows a transformer profile which was created and measured for the first time on June 1st 2010. Then this transformer was measured again on the 1st of each month. This means that the transformer Profile was loaded from the archive each time a measurement was required and done. In the example above, it is the 1st of September. The transformer Profile is loaded (made active) and a measurement is done. The new measurement data was saved and stored (linked) with the transformer Profile. Thus creating a history for this particular transformer.



MAIN MENU

MAIN MENU SCREEN

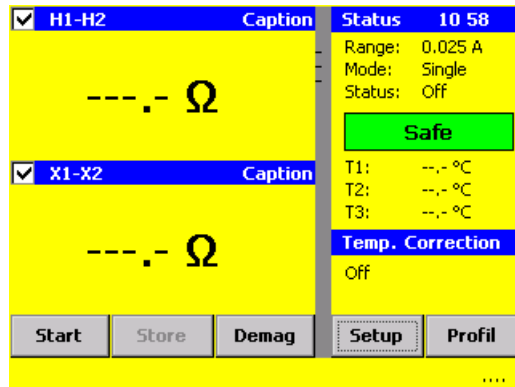

The Touch screen enables quick navigation by pressing directly on the screen.

e.g. If you would like to change the current range, press on the text "Range" and the Menu Range will open. This is a short cut step to the Range menu. Or you can also access the Range menu by going through the Setup menu.

Start

Starts the measurement and the selected Current is applied.

Stop

Stops the measurement; DO NOT disconnect the measuring cables BEFORE the Green light is on and the indication Safe appears. This button is active when Current is on (Start is active when Current is off).

Store

Stores the results while the measuring Current is on.

Demag

Demagnetizes the core of a test object. See pages 32 and 109.

Setup

Goes directly to the Setup Menu. See page 33.

Profiles⁵

Goes directly in the Profile Menu. See page 56.

If you don't use Profiles, you will have the Result Button. See page 52.

⁵ If you have not selected "Use Profiles" in the Setup Menu, you will see "Results" instead of the "Profile" button.

H1-H2

Enable or Disable measuring channel 1 by selecting the small box (next to caption H1-H2).

X1-X2

Enable or Disable measuring channel 2 by selecting the small box (next to caption X1-X2).

Status

Shows the measurement parameters.

Temp. Correction

Shows the temperature parameters. Temperature variables can be modified by pressing the Setup Button or directly in the text (--.-°C). See page 49.



START

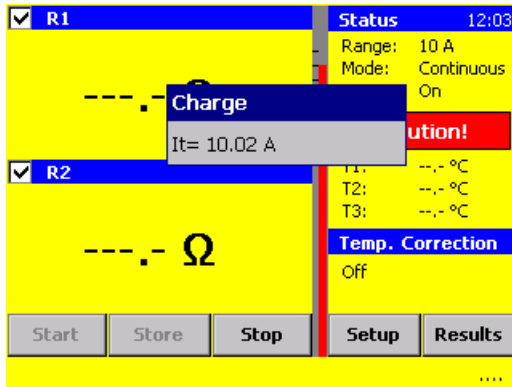

Press Start.

Instrument starts to charge test object with the selected current.

Maximum current is shown on the Range Status bar.

STORE

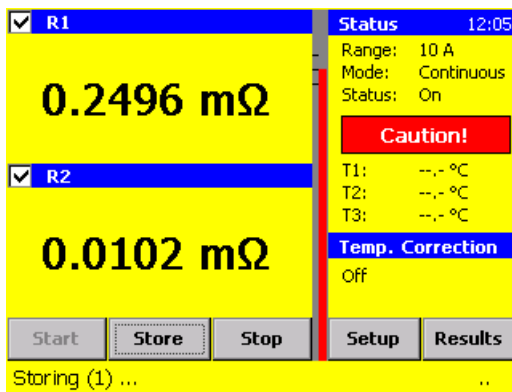

Press Store.

Instrument stores the value shown in the Display (R1, R2).

The measurement doesn't stop.

STOP

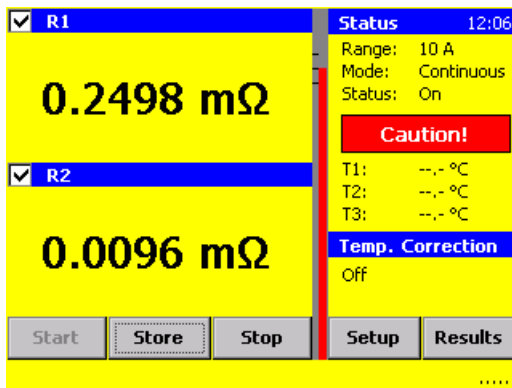

Press Stop.

Instrument stops the measurement and begins the discharge process.

DO NOT disconnect the measuring cables until the green light is on and the indication for Safe mode appears.

DEMAG

The Demagnetization procedure demagnetizes the test object (e.g. transformer core). The Demag button appears after measurement is finished.

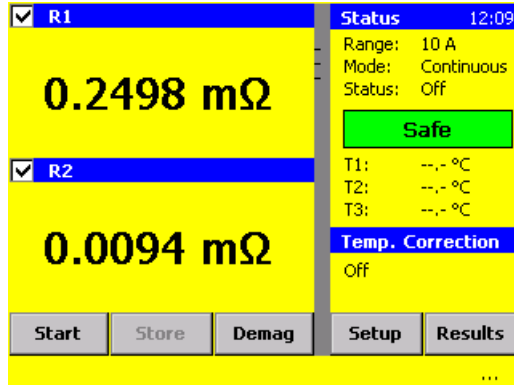

Press Demag.

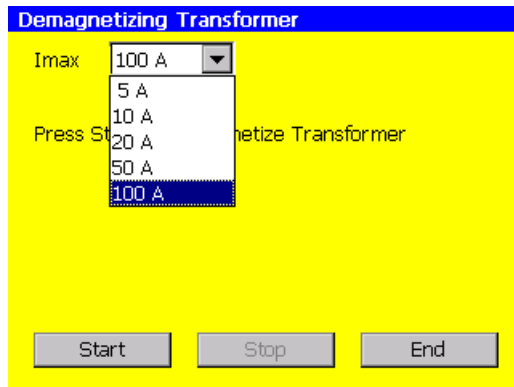

Select the demagnetizing current, which is usually the same current as the test current, and then press start.

The Demagnetizing procedure runs automatically.

For a technical description of the demagnetizing feature, see “Demagnetizing” on page 109.



SETUP

By pressing the Setup button, the Setup screen will appear.

Press the appropriate text box (Caption) in the main menu screen and the Setup screen will automatically appear with tabs for selecting screens for Config, Mode, Range, Temperature Correction or similar.

General

This screen allows the selection, modification and setting of the General Instrument parameters.

Config

This menu allows the changing of the caption of the channels.

If you use profiles, you can select the windings you would like to measure. Also, if a multiplexer is selected, it will automatically control the system after this selection is made.

Mode

This screen allows the selection and setting of the measurement mode (single, continuous or interval).

Range

This screen allows the selection, modification and setting of the range for the Test Current.

Temp. Corr.

This screen activates the temperature correction feature.

GENERAL

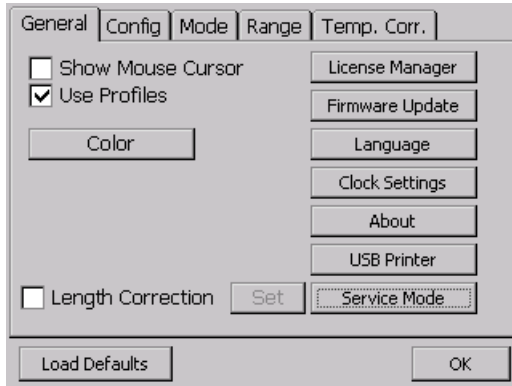

From the Main screen, press Setup.
Then enter the General Setup Menu.

Show Mouse Cursor

Show or hide the Mouse Cursor. Useful if operating with a USB Interface mouse.
The mouse cursor appears automatically after the USB mouse is connected.
You can control the instrument with a USB mouse, track ball and/or keyboard.

Use Profiles

This allows operation of, or access to, transformer profiles.

For more information see "Menu Structure Using Profiles" on page 26 or "Menu Structure Without Using Profiles" on page 25.



Color

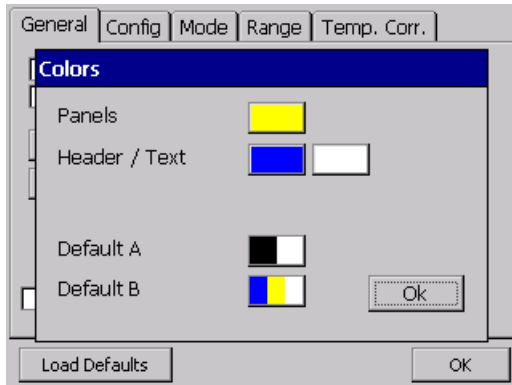

Shows the selected colors displayed on the screen.

The User may change the colors on the touch screen display by selecting appropriate colors for each.

Default A: Black and white screen

Default B: Colored screen

Black and white may be selected on certain outdoor conditions. For example in bright sun light.

Select the corresponding color button to change the color:

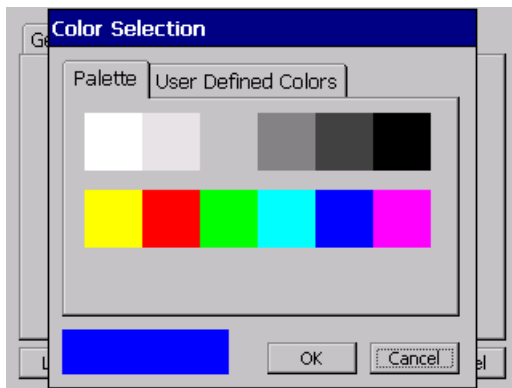

Palette: Choose a color by selecting a predefined color available.

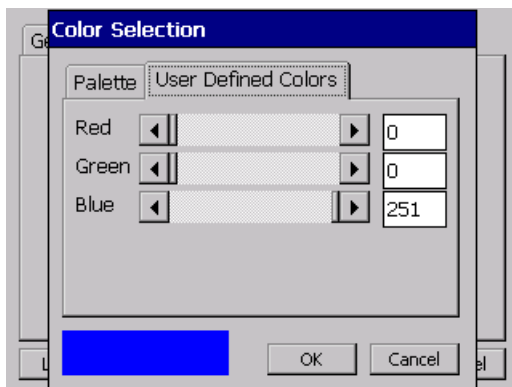

User Defined Colors: Choose a color by manually adjusting the color select bar.

Length Correction

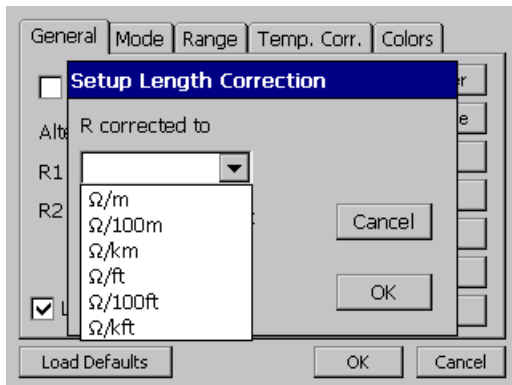

Change the measuring unit from Ohm to Ohm/Length. The test results are then corrected to the selected display method.

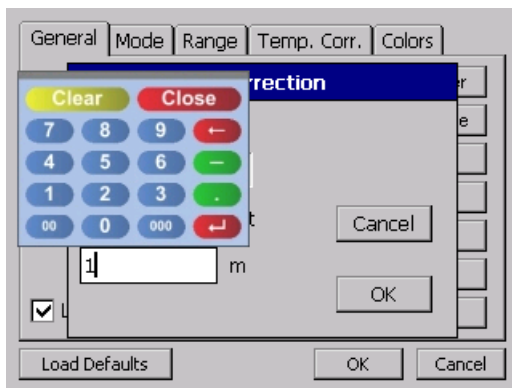

The length of the test object is predefined by the customer. Enter the length of the test specimen.



License Manager

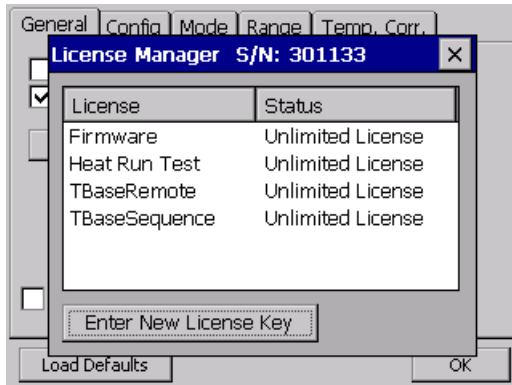

The License Manager shows the validity of the license for the use of the instrument, the Heat Run Test, TBase Remote, and TBase Sequence-Softwares.

If there is no valid license status displayed, contact your local representative or Raytech.

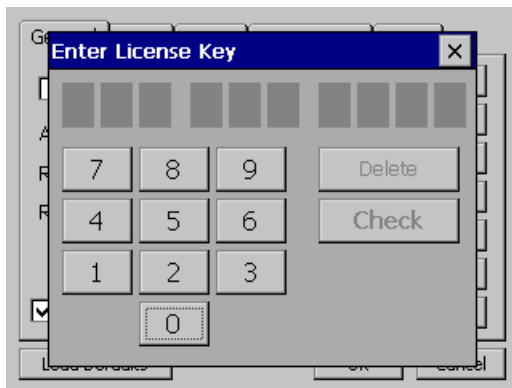

To modify or extend the license, enter a new license code.

The license code is generated by Raytech.

Firmware Update

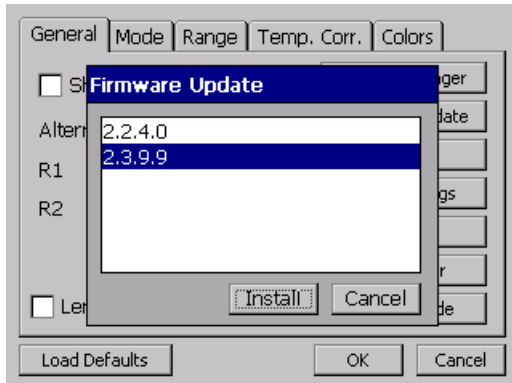

New Firmware versions are available free of charge at <http://www.RaytechUSA.com>.

Download the new Firmware (.zip file) onto your USB key on the root directory (Not into a sub-directory and **DO NOT** Unzip it).

Connect the USB key to the instrument and press install. The system will detect and automatically install the new firmware and restart the system.

Language

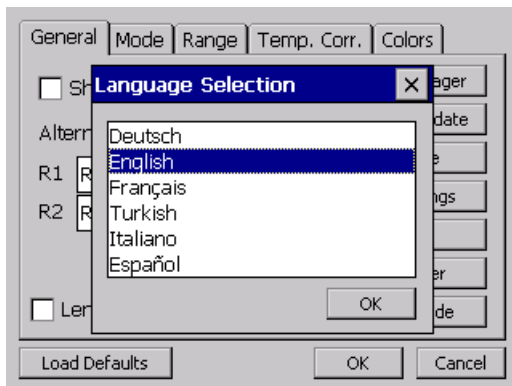

The selection of language for the operating menu can be made.

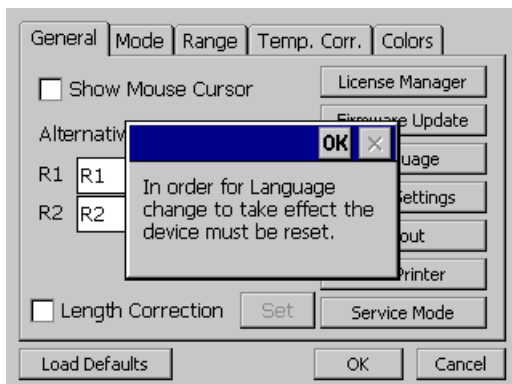

Restart the instrument to activate the desired language selected.



Clock Settings

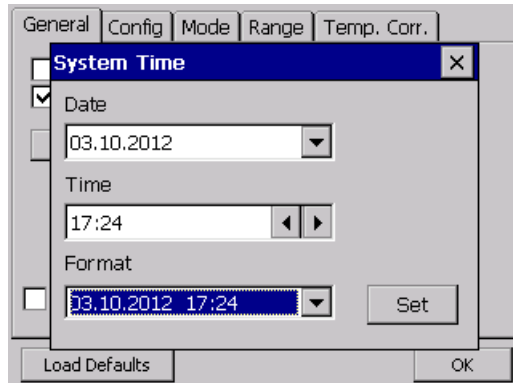

Adjustment of the internal clock can be made.

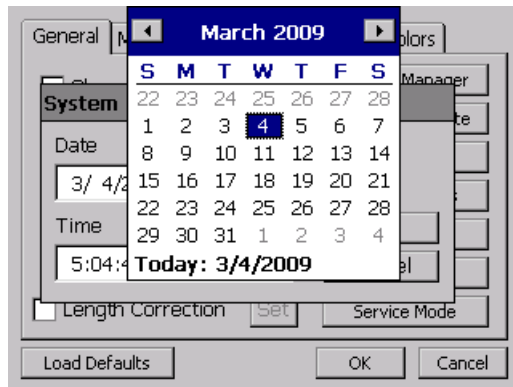

Date

By pressing the arrow, the calendar will be displayed. Select the date by pressing on the actual day.

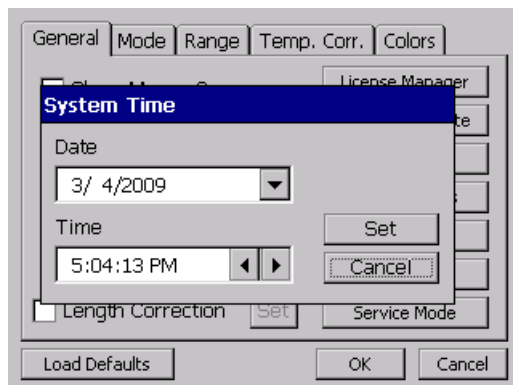

Time

Select hour/minute/second by highlighting the numbers in the clock.

Pressing the arrows will increase or decrease the time settings.

About

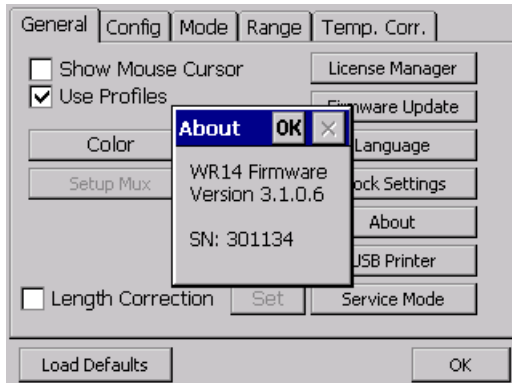

Shows the Firmware Version and Serial Number of the instrument.

USB Printer

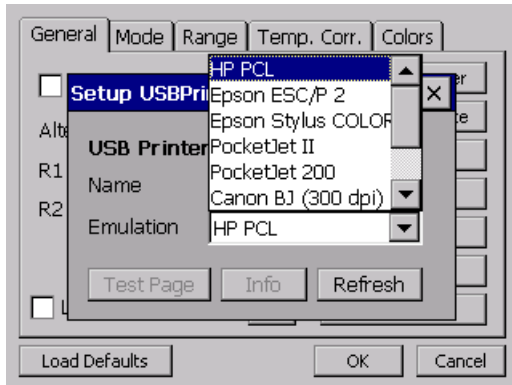

Certain external USB Printers can be connected. Select the desired printer to print results. Printers not listed are not supported.

For more information, see “USB Printer Info” on page 103.



Service Mode

There are several embedded codes to allow different settings, e.g. calibrate the touchscreen, activate the USB-driver and so on. For more information see “Service Mode” on page 97.

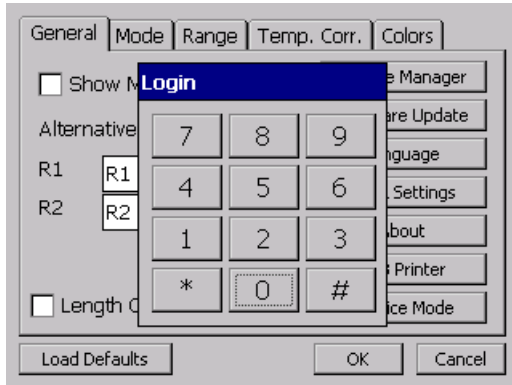

The Service Mode has a limited access.

Enter the corresponding code or exit directly by pressing “#.”

CONFIG

The Config (Configuration) Menu may look differently depending upon if Profiles is selected or not. For more information about using Profiles or to deactivate Profiles, see “Operating Menu” on page 23.

With Profiles Deactivated⁶

In the tab Config, you can change the name (Caption) of the measurement channels.

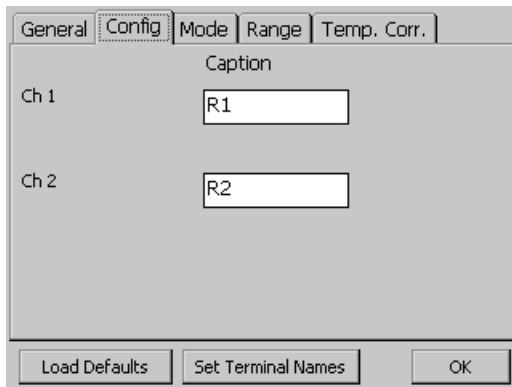

Click on the white field to change the name (Caption) of the measurement channels.

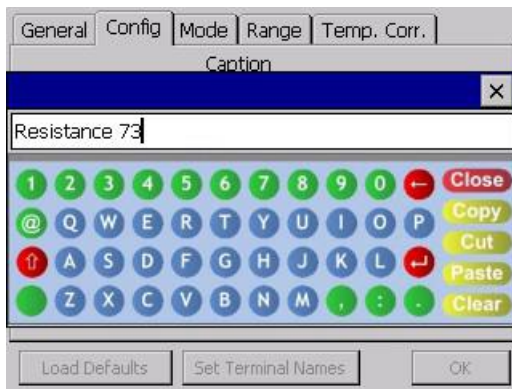

Enter a name.

⁶ Do not select “Use Profiles” in the Setup under “General.”



Using Profiles⁷

When using Profiles, you can select (name) what you want to measure on your test object. The measurement results are then stored with the corresponding label in the correct place.

This feature is very useful if utilizing a Raytech multiplexer which will automatically set the appropriate relay. Thus, with a multiplexer, you connect the measurement cables to a Transformer only once and all measurements are completed without changing any cables.

WS: Select the Winding System (1 Primary, 2 Secondary or 3 Tertiary side of the Transformer). The configuration of the appropriate winding can be made.

Caption: Select the point locations to be measured.

⁷ Check the check box in the Setup under “General.”

	WS	Caption	Tap
Ch 1	1 D	a: H1-H2 # H2-H1	+2 -1 0
Ch 2	2 yn	a: X1-X2 # X1-X2	+1 +2 +3 +4 +5

Load Defaults Set Terminal Names OK

Tap: If the transformer has Taps, select the Tap to be measured.

	WS	Caption	Tap
Ch 1	1 D	a: H1-H2 # H1-H2	+4
Ch 2	2 yn	a: X1-X2 # X1-X2	

Load Defaults Set Terminal Names OK



MODE

Single

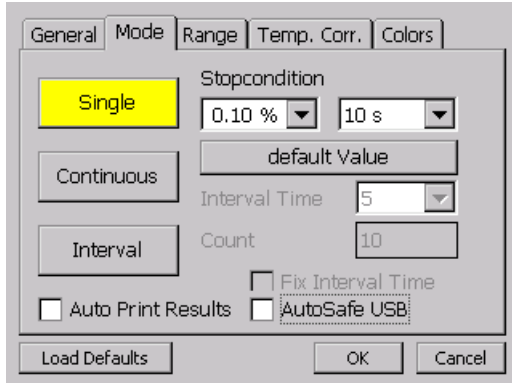

Performs 1 single measurement.

Stop condition:

Stops the measurement as soon as the result is within the selected conditions.

(Example Shown: within $\pm 0.10\%$ during 10 Seconds of time)

Continuous

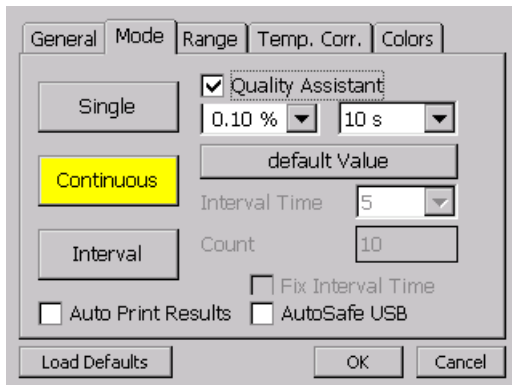

Performs continuous measurement until the measurement is stopped by the user.

Quality Assistant:

If the result is within the selected parameters, a **green** light in the main screen will illuminate and indicate this condition.

If the result is out of the selected parameters, a **red** light in the main screen will illuminate and indicate this condition.

If the selected conditions are almost met, a **yellow** light in the main screen will illuminate.

Interval

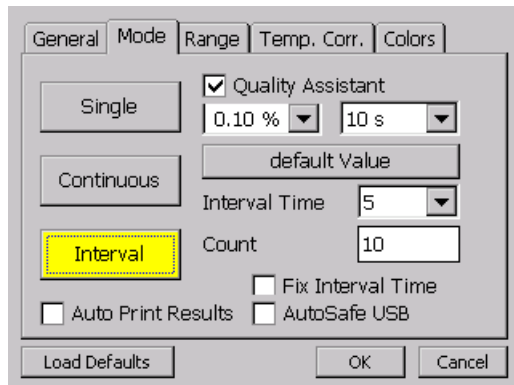

Performs a selected number of measurements (selected with “Count”) and stores the result.

Interval Time:

The time (in Seconds) selected between 2 measurements. It will automatically store the result.

Count:

The number of measurements to be taken.

When all measurements are taken, the system halts and discharges the Transformer.

Fix Interval Time:

Selects the interval time from Start Time instead of from the 1st measurement point.

e.g. If the Interval Time is set to 10 seconds and the first measurement is taken at 27 seconds, the system stores results at 27, 37, 47... seconds, if the check-box is not checked. However, if the check box is checked, the results will be taken and stored at 27, 30, 40, 50...seconds.

Note:

The current remains ON for the duration of the test and automatically stops after the “Count” number of measurements are taken.

**Quality Assistant:**

If the result is within the selected parameters, a **green** light in the main screen will indicate this condition and automatically store the result. In the interval mode, the selected Interval measurement will start recording results.

If the result is out of the selected parameters, a **red** light in the main screen will indicate this condition. No results are stored.

If the selected conditions are almost met, a **yellow** light in the main screen will illuminate and indicate this condition. No results are stored.

Auto Print Results⁸

If this feature is selected, the instrument will also output to a connected printer when the measurements are stored.

AutoSave USB:

The results will also be stored on a USB Key, if connected to the instrument during a measurement.

⁸ Not available in the WR14.

RANGE

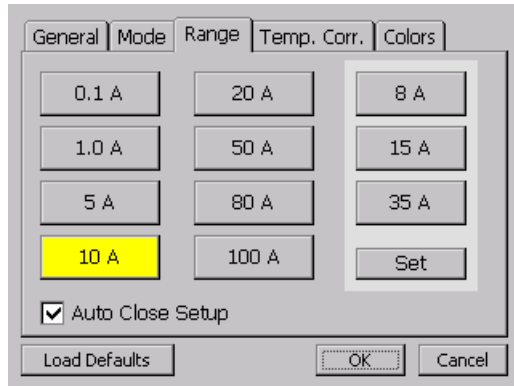

Selects the current range⁹ for the measurement.

Auto Close Setup:

Closes the Setup Window after the Current Range selection is made without pressing OK.

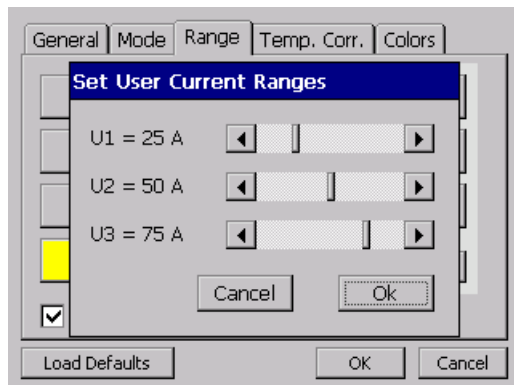

For adjusting the User Settings:

Press “**Set**”

Adjust all 3 settings by moving the cursor left or right to the desired Current level. Press OK when finished.

⁹ The maximum current of the WR50 is 50A. The maximum current of the WR14 is 15A.



TEMPERATURE CORRECTION

General Mode Range Temp. Corr. Colors

Activated

Coefficient Reference Value

Cu (234.5 °C) 25 °C

Al (225 °C)

User defined 180 °C

Channels

T1 T2 T3

Ext 25 °C

Load Defaults OK Cancel

Activated:

Temperature correction is activated when the box is marked. The displayed test value then is a calculated result dependent upon the parameters selected.

Coefficient:

Choose the temperature coefficient of the material to be measured; Either CU (copper), AL (aluminum) or User defined. Temperature correction parameters are then displayed on the touch screen panel.

Reference value:

The reference (base) temperature is the temperature correction factor that is being referred to.

Channels:

This allows the user to select which measurement channel (temperature probe or external temperature meter) that the temperature correction is applied to. If the required selection is more than one channel, then the average value of the selected measurement channels is calculated.

Ext.:

Manual input of an external measured temperature. For example, an external temperature meter.

Example for calculation:

In the example below, the measurement object is Copper and will be corrected to 25 degrees Celsius based on the temperature input of temperature channel 1.

If a temperature probe (optional accessory part number: 2021N-26001) is not available, activate the "Ext" box and fill in the temperature of the test object that was measured with an external temperature meter.

The correction formula:

$$R_s = R_m \frac{T_s + T_k}{T_m + T_k}$$

- Rs Resistance corrected
- Rm Measured resistance
- Ts Desired reference temperature
- Tm The temperature at which resistance was/is measured
- Tk 234.5 for copper
225.0 for aluminum
(aluminum may be as high as 240)

Alternative: Correction with “alpha25” to calculate Tk with the formula:

$$T_k = \frac{1}{\alpha_{25}} - 25$$

When temperature correction is activated, the Main Test Screen appears as below:

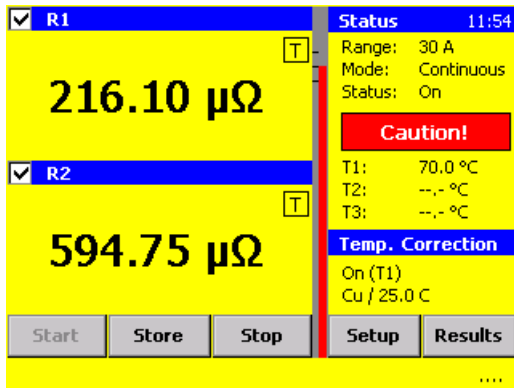

The “T” in the measuring channel box shows that the displayed resistance value is corrected. In this example it is corrected to 25 °C using Tk of Copper and referring to Temperature probe 1.



To view the actual result without the temperature correction, Press the “T” during the measurement:

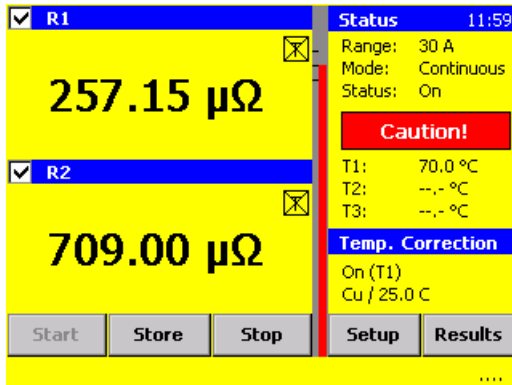

The “crossed” “T” shows that the displayed resistance value is NOT corrected.

The corrected AND the uncorrected values are stored in memory whether or not the correction is activated in the display.

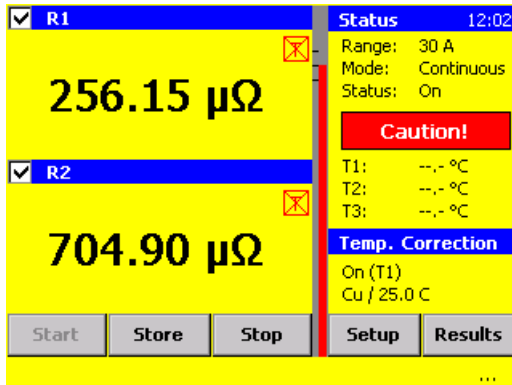

If the display shows a crossed Red T, the result is not corrected because a temperature probe is missing or not recognized by the system.

RESULTS¹⁰

The Results button appears on the main screen in the lower right hand corner. Press the Results button to view results in Standard mode. If Profiles mode has been turned on, then the “Results” button on the main screen changes to “Profile”. The Profile results can be found under the tabs: Profile, Info, Results.

Time	Mode	Range	Remarks
07.09.2012 16:31	C	0.025	
01.10.2012 16:41	C	1	
04.10.2012 12:07	C	15	
04.10.2012 12:07	C	15	
04.10.2012 12:07	S	15	
04.10.2012 12:08	I	15	
04.10.2012 12:09	C	10	
04.10.2012 12:09	C	1	
04.10.2012 12:10	C	0.2	
04.10.2012 12:11	C	2	
04.10.2012 12:12	C	7	

Details Diagram Delete Print.. Esc

Shows the overview of the measurements which are sorted by Date/Time.

Time	Mode	Range	Remarks
07.09.2012 16:31	C	0.025	
01.10.2012 16:41	C	1	
04.10.2012 12:07	C	15	
04.10.2012 12:07	C	15	
04.10.2012 12:07	S	15	
04.10.2012 12:08	I	15	
04.10.2012 12:09	C	10	
04.10.2012 12:09	C	1	
04.10.2012 12:10	C	0.2	
04.10.2012 12:11	C	2	
04.10.2012 12:12	C	7	

Details Diagram Delete Print.. Esc

You can select multiple results.

¹⁰ See “Operating Menu” on page 23 for instructions regarding how you can select it.



Details

Caption	Rmeas	Rcorr	T1	T2	T3	Text
1V-1W	164.5 $\mu\Omega$	164.5 $\mu\Omega$	70.0			
1V-1W	164.6 $\mu\Omega$	164.6 $\mu\Omega$	70.0			
1V-1W	164.7 $\mu\Omega$	164.7 $\mu\Omega$	70.0			
2U-2V	0.1 $\mu\Omega$	0.1 $\mu\Omega$	70.0			
2U-2V	0.2 $\mu\Omega$	0.2 $\mu\Omega$	70.0			

Header Diagram Delete Print Esc

After selecting results, press Details and view the screen with details of the selected measurements.

If no measurements were selected, the details of all stored measurements are displayed.

Return to the results overview by selecting "Header".

Caption: This is the caption (name) of the measurement channel.

Rmeas: This is the measurement Result without a temperature correction.

Rcorr: This is the temperature corrected measurement result.

T1-T3: The temperature of the probes.

Text: Manual input of temperature value (measured with an external temperature meter).

r	T1	T2	T3	Text	Itest	Ch	Time
5 $\mu\Omega$	70.0				7.190	1	00:00:04
6 $\mu\Omega$	70.0				7.190	1	00:00:02
7 $\mu\Omega$	70.0				7.191	1	00:00:01
$\mu\Omega$	70.0				7.190	2	00:00:04
$\mu\Omega$	70.0				7.190	2	00:00:02

Header Diagram Delete Print Esc

Scroll to the right to view additional details.

Itest: The measurement current.

Ch: The channel which measured the result.

Time: Time between the start of the measurement and memory storage.

Diagram

Caption	Rmeas	Rcorr	T1	T2	T3	Text
1V-1W	164.5 $\mu\Omega$	164.5 $\mu\Omega$	70.0			
1V-1W	164.6 $\mu\Omega$	164.6 $\mu\Omega$	70.0			
1V-1W	164.7 $\mu\Omega$	164.7 $\mu\Omega$	70.0			
2U-2V	0.1 $\mu\Omega$	0.1 $\mu\Omega$	70.0			
2U-2V	0.2 $\mu\Omega$	0.2 $\mu\Omega$	70.0			

Select Diagram to analyze the measurement graphically.

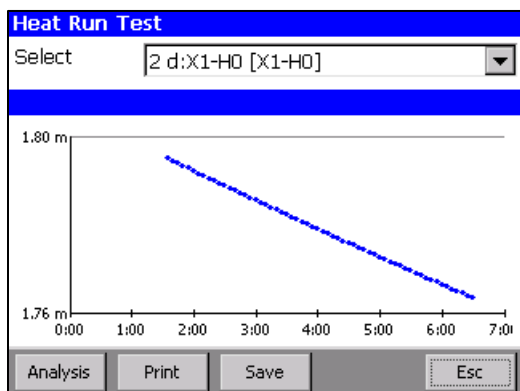

A graph displayed as a function of time (e.g. cooling curve of a transformer).

The **Analysis**¹¹ button is only available with the option HRT (Heat Run Test).

For an explanation see “Heat Run Test Software” on page 65.

The license code for the Heat Run Test is available from Raytech or a Raytech representative.

Print: Prints the graph on the panel mount (internal) Printer.

Save¹²: Press Save and the graph will be stored on the USB Key as a .gif file. For more information, see page 70.

Esc: Returns to the result details.

¹¹ Only available if the diagram is a function of time.

¹² Only available if the diagram is a function of time.



Print/Export

Print / export the selected measurements. If no measurements are selected, the entire memory will be printed or exported.

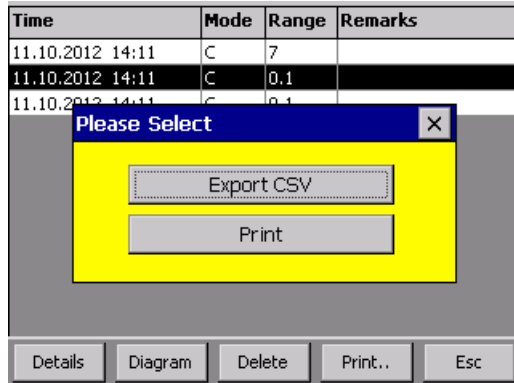

Press "Print" to print the results.

Press "Export CSV" to export the data in a csv file.

If you choose "Export CSV," the selected data will be exported in a CSV file that is named with the serial number of the instrument and the date and time. You can locate the file in the directory: Raytech\EXPORT on the USB Key.

To select the CSV Separator, see "CSV Separator" on page 99.

Esc

"Esc" returns to the main screen.

PROFILE¹³

Press Profile in the main screen to get an overview of the different transformer profiles.



NOTE!

For an introduction to Transformer Profiles and Data Structure, see page 27.

You can switch between the Active profile, Internal profiles (stored internally on the instrument) or profiles stored on a USB Key.

This is an example of the Active transformer Profile.

Name	Type	S/N	Last Res
01.08.2012 ste	Ynyn4		01.08.12
14.05.2012 16	Ynyn4		
28.06.2012 17	Dy?d?		
demo d:yn 5	Dyn5 Taps(3)		05.07.12
New Profile 19.	Ynya0		
Pizza	Dyn5 Taps(3)	1	02.07.12
Quickstart	ΔY3	234	
steff 18.07.201	Dyn5 Taps(3)	21649 T/2/2	18.07.12
steff temp	ΔYn3Z?	99999	17.07.12

This is an example of Profiles stored on a USB Key.

¹³ "Use Profile" section, see "Operating Menu" on page 23.



Create a new Profile

Press new on the tab "Active." A message appears asking if you want to create a completely new transformer Profile or just make a new measurement under the Active Profile.

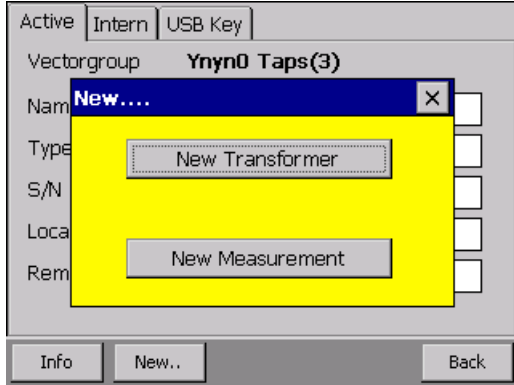

Select "New Transformer."

First select the configuration of the Primary winding of the transformer. Choose the corresponding configuration of your transformer's Primary side from the Setup menu shown below. After selection, the instrument will display the Primary configuration in the highlighted box and automatically move to the next highlighted box to select the Secondary winding of the transformer.

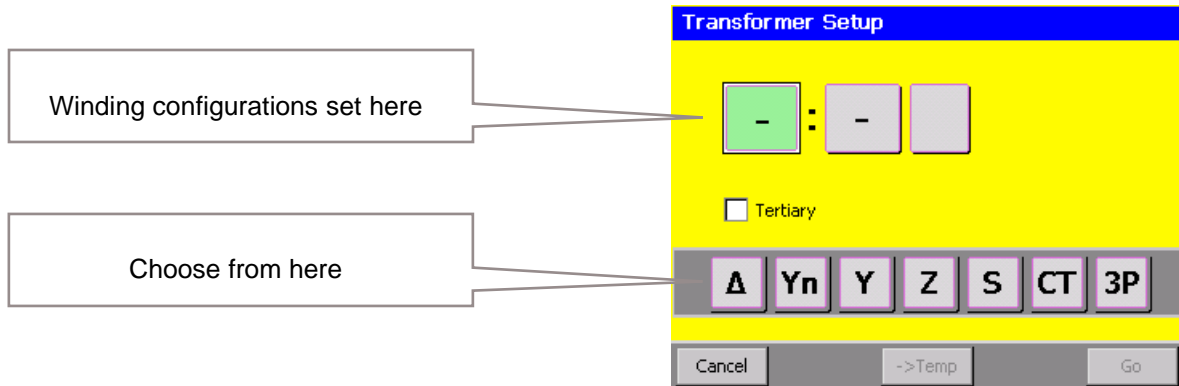

Taps:

Tap changer positions can also be defined for every winding system.

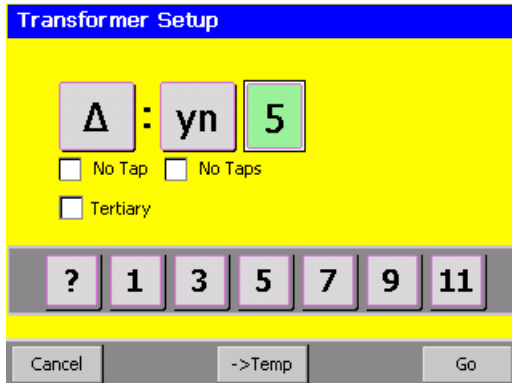

Touch the check box beside the text "No. Tap" (Number of Taps) below the transformer coil that you wish to enter the number of Tap positions.

A screen appears to allow the setting of the number of tap changer position steps.

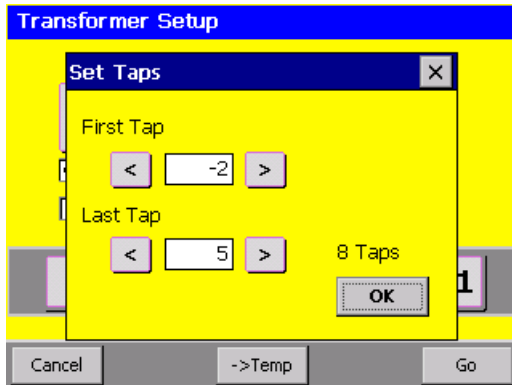

Use the arrows "<" or ">" to increase or decrease first and last tap steps.

The First Tap setting (-2 shown): Lower Taps

The Last Tap setting (5 shown): Upper Taps

The total number of Taps selected will be displayed above OK.

Confirm with OK to set (e.g. 8) Taps. View the number of Taps in this Transformer setup screen.

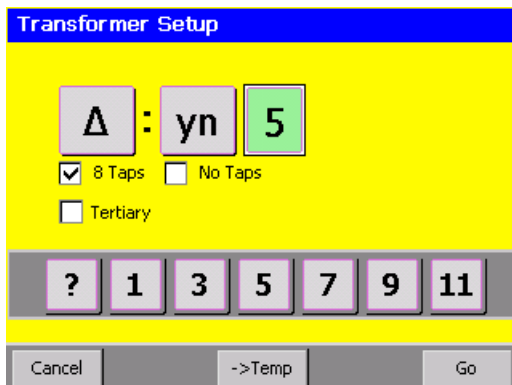

Your Transformer may have Tap positions on the Primary and on the Secondary windings. Use the same procedure to define the Secondary Tap positions.



Tertiary Winding System:

Transformers may have a Primary, Secondary and Tertiary winding. Activate the “Tertiary” option, by touching the check box.

Buttons appear for the additional winding.

It is also possible to define Tap positions for this third winding.

When all parameters are complete, press "Go" to create a new Profile.

To generate this transformer as a template press " ->Temp." For more information about templates, see "Working with Templates" on page 61.

Press "Go" to view the screen to fill in the data from the nameplate of the transformer.

The default Name is the date and the time. This can be edited.

Select the field you would like to change/edit and use the screen to change the value or connect a USB Keyboard to the instrument.

Press “Close” after the name is entered.

Select another field to edit/change.

Active Intern USB Key

Vectorgroup **Dyn5zn8 Taps(14)**

Name Example Trafo

Type 654nh87

S/N 432865

Location Bremgarten

Remarks Bemerkungen

Info New.. Back

Select 'Info' for more information about the transformer.

Name:Example Trafo

- [-] Rated Voltage
 - [+] Primary D
 - [-] Secondary yn - 5
 - 0 :0kV
 - [+] Tertiary zn - 8
- [+] Name Plate
- Results

Edit Esc

This is the location where additional information about the transformer can be added.

Load Transformer Profile from Archive

When preparing to test a transformer, check to see if its Profile is already stored internally in the instrument or on a USB (key) memory stick. "Use Profiles" must be selected in the General Tab under Setup. The USB key tab will only be shown if a USB key is inserted in the instrument.

Active Intern USB Key

Name	Type	S/N	La:
12.10.2012 13	Yny4	Template	
12.10.2012 11	Dyn5zn8 Taps(14)	Template	
steff 18.07.201	Dyn5 Taps(3)	21649 T/2/2	
demo d:yn 5	Dyn5 Taps(3)		
12.10.2012 14	Dyn3	ggrr	
28.06.2012 17	Dy?d?		
Quickstart	ΔY3	234	
No Profile	-		11

Info Load Delete.. Export Back

Touch the tap (Intern or USB Key) and select the transformer you would like to load.

The Profile name that is written in blue is the active Transformer.



Working with Templates

When testing many of the same transformers, it is possible to create a new transformer Profile as a Template. Creating a Profile Template allows editing of parameters, Names, s/n etc.



NOTE!
Use this option if you have to measure many transformers of the same type.

To make a Template, review the instructions on making a Profile in "Create a New Profile" on page 57. However, after all parameters have been entered, press "->Temp" instead of "Go".

Active	Intern	USB Key
Vectorgroup Dyn5 Taps(3)		
Name	08.11.2012 15:06	
Type		
S/N	Template	
Location		
Remarks		
Info	New..	Back

After creating a new Profile and pressing "-> Temp," rename the template with another name other than the date and the time which are displayed by default.

Edit any other information (Type, Location, etc.) as required for the Template.

Active	Intern	USB Key		
Name	Type	S/N	Last Result	L
08.11.2012 13	Ynz5	Template		
08.11.2012 13	Ynyn4			
08.11.2012 13	Ynyn4y6			
Example profile	Dyn5 Taps(3)	Template		Bl
No Profile	-			
ttt	Dyn5 Taps(3)	6655	08.11.12	Bt
Edit	Clone	Delete..	Export	Back

The new profile will be created with a minimum of information, and it will be stored in the archive of the instrument. In the S/N (serial number) field, the name "Template" will be entered by default.

Name	Type	S/N	Last Result	L
08.11.2012 13	Ynz5	Template		
08.11.2012 13	Ynyn4			
08.11.2012 13	Ynyn4y6			
Example profile	Dyn5 Taps(3)	Template		Bi
No Profile	-			
ttt	Dyn5 Taps(3)	6655	08.11.12	Bi

Buttons: Edit, Clone, Delete.., Export, Back

Template Profiles can be cloned in the Archive menu. The instrument creates a Transformer Profile based on the template.

Highlight the Template profile and the “Clone” button will appear in the display.

It is only possible to Clone a Profile that was saved as a Template. Newly cloned Profiles cannot be cloned.

Name	Type	S/N	Last Result	L
08.11.2012 13	Ynz5	Template		
08.11.2012 13	Ynyn4			

Transformer Name [X]

Example profile

1 2 3 4 5 6 7 8 9 0 ← Close
 @ Q W E R T Y U I O P Copy
 ↑ A S D F G H J K L ↓ Paste
 Z X C V B N M , : . Clear

You will be asked to enter a new transformer name and then the serial number for the newly cloned Profile.

Enter the Transformer Name and then the Serial Number, then touch “Close” to save the Profile.

After entering this information, you have a new Profile to work with.

It's useful to use this sequence of cloning when there are numerous transformers of the same type.



Diagram

Caption	Rmeas	Rcorr	T1	T2	T3	Text
1V-1W	164.5 $\mu\Omega$	164.5 $\mu\Omega$	70.0			
1V-1W	164.6 $\mu\Omega$	164.6 $\mu\Omega$	70.0			
1V-1W	164.7 $\mu\Omega$	164.7 $\mu\Omega$	70.0			
2U-2V	0.1 $\mu\Omega$	0.1 $\mu\Omega$	70.0			
2U-2V	0.2 $\mu\Omega$	0.2 $\mu\Omega$	70.0			

Header Diagram Delete Print Esc

Select Diagram to analyze the measurements graphically.

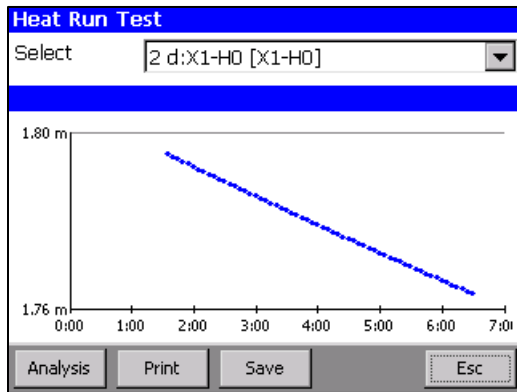

Displayed is a graph as a function of time (e.g. cooling curve of a transformer)

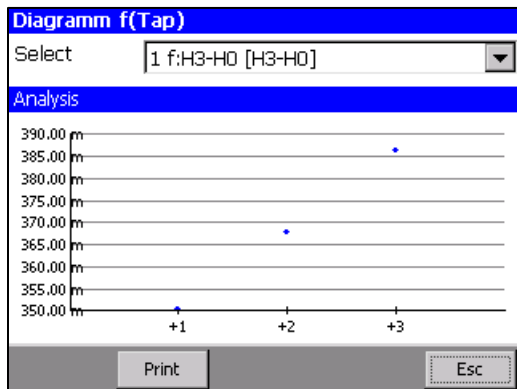

With a Tap changer, the curve is a function of the Taps. In this example there are 3 Taps.¹⁴

¹⁴ F(Tap) is only available if you are working with profiles.

OPTIONS

TEMPERATURE MEASUREMENT

Raytech WR series Instruments are very accurate and precise test systems. To take full advantage of this high accuracy, the recording of the temperature of the device under test is highly recommended. This is due to the characteristics of the increase in resistance of a metallic object as its temperature increases. Incorporated into the system are temperature compensation tables for Copper and Aluminum. These tables are used to automatically calculate the conversion factor to a known reference temperature.

Temperature Correction Settings: see page 49.

The system allows up to three (3) temperature probes to be used for the purpose of recording temperatures. Optional Part Number: 2021N-26001, can be purchased for this purpose.

The temperature probe is mounted to a flexible cable that plugs into the rear panel of the WR-instruments. This option enables the user to record the ambient temperature and/or the actual temperature of the device under test. A set of three (3) temperature probes can be ordered to allow complete temperature measurements at three different reading points.

The instrument will automatically detect when a temperature probe is connected. The temperature will be displayed on the instrument screen during a test and will appear on the printed report. The temperature, as well as the test results, can be saved into memory.

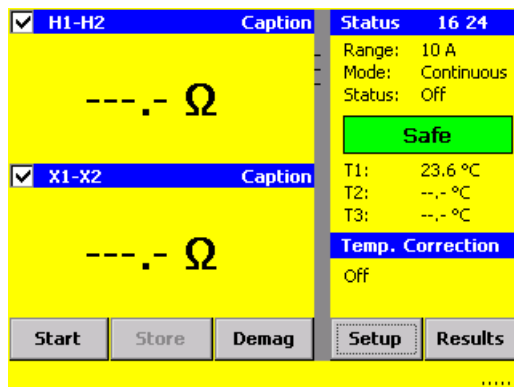

As soon as a temperature probe is connected, the value is displayed on the main screen and will automatically be stored to the correspondent resistance value.



HEAT RUN TEST SOFTWARE

The Heat Run Test Software, option 2042N-11001, is used to analyze the measurement results of the copper loss test of the windings of a transformer and to calculate the resistance values of the winding at the working temperature (time zero).

INTRODUCTION

The Heat Run Test (HRT) performs a measurement during the cooling curve of a transformer after the transformer has been heated.

The measurement is made in the interval¹⁵ mode without temperature correction.

In the Setup Menu the following settings must be made:

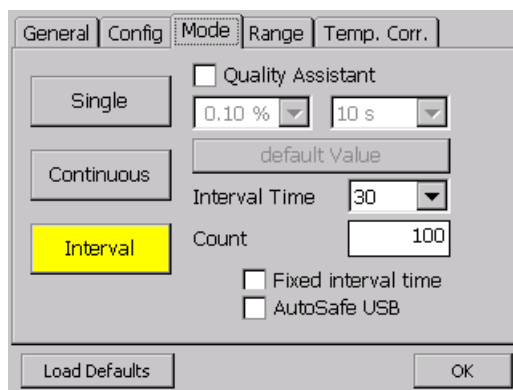

Activate “Interval Mode“ and select the interval time. Select the time in seconds between measuring points (Interval Time) and the number of data points (Count).

Disable the Quality Assistant.

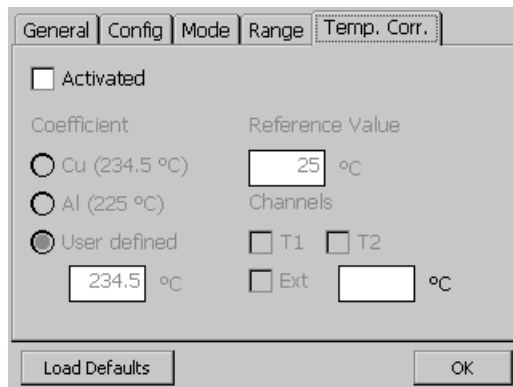

The Temperature Correction must be deactivated for heat run testing.

¹⁵ See “Interval” on page 46.

MEASUREMENT WITH INTERVAL MODE FOR HRT

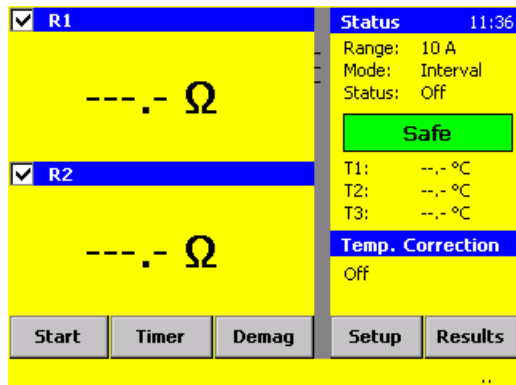

The heat run timer must be started the moment that the heat source is switched off from the test object.

Press the “Timer” Button on the main screen to start the timer.

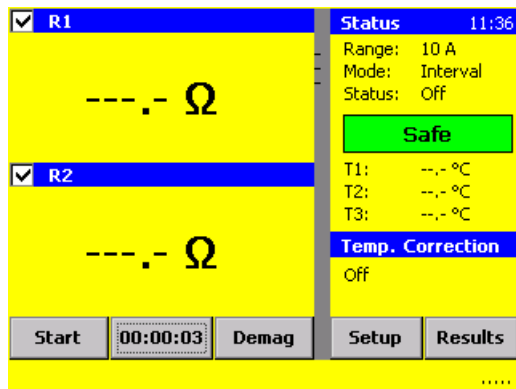

The timer starts running.

The timer can be halted, at any time, by pressing the button a second time.

Note: The test current is NOT switched on at this time.

After starting the timer, disconnect the power cables or heat source of the test object and connect the measurement cables of the instrument.

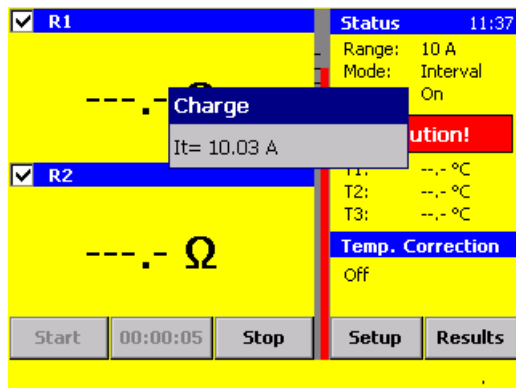

Measurement results should be obtained as quickly as possible.

After the measuring cables are attached to the transformer windings, press “START” to start the measurement.

The current is applied and the system charges the transformer winding(s) to be measured.

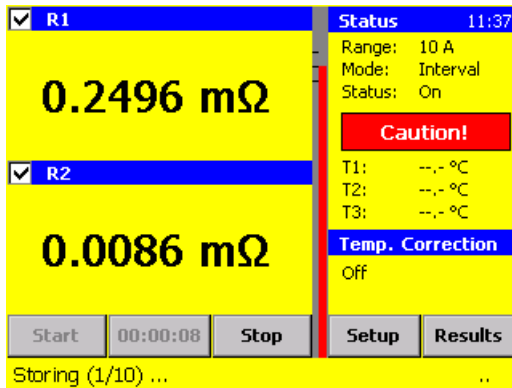

After charging the transformer, the instrument system monitors the measurements until the results are stable.

The results are then stored automatically.

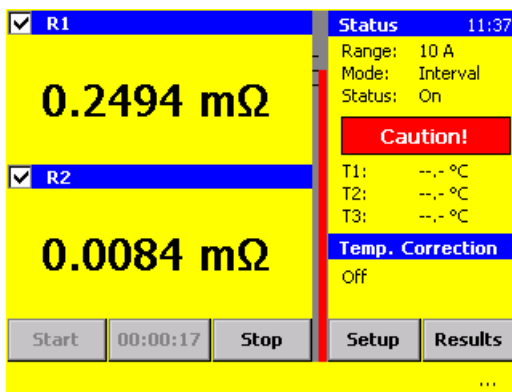

Press the “Stop” Button, at any time, to halt the measurement.

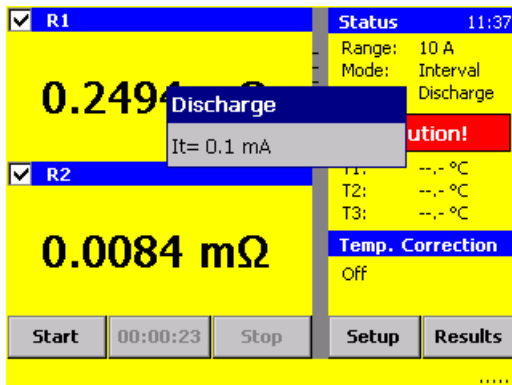

After storing the last measurement, the instrument turns off the output Current, stops the measurement and automatically discharges the transformer until the test object is safe.

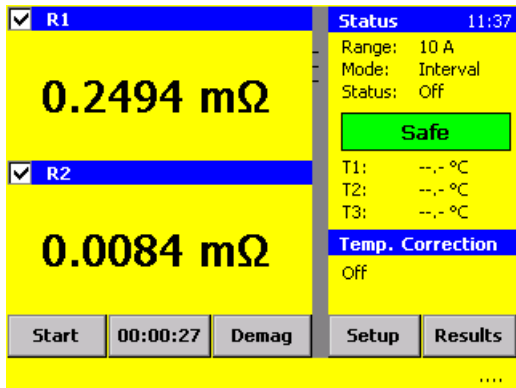

Although the measurement is finished, the timer continues to operate. This allows further measurements on other windings of the same transformer.

The timer can be halted, at any time, by pressing the Timer button.

ANALYZING THE HRT RESULTS

Select the measurement results you would like to analyze.

Analyses of the recorded data is slightly different if Profiles mode has been used or not.

Profiles: From the Main Screen, select:

- Profiles
- The Transformer
- Info
- The measurement number
- Result
- The measurement date
- Diagram

No Profiles: From the Main Screen, select:

- Results
- The measurement date
- Diagram

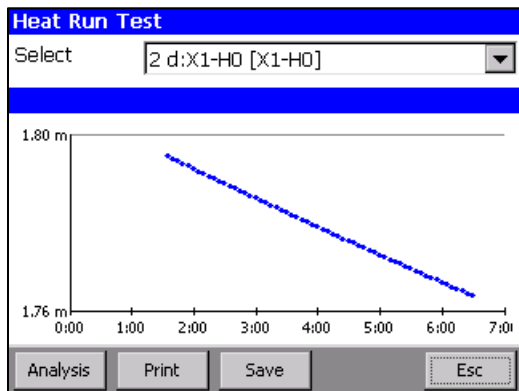

Displayed on the screen are the selected results shown graphically.

If you have the Heat Run Test Software license, the "Analysis" Button is visible and can be selected for the calculation.

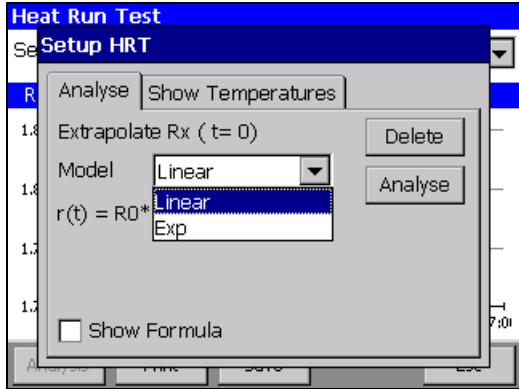

Press “Analyse.”

You’ll be asked for the “Approximation” Model to calculate the value of the Winding at time = zero.

Select the Approximation Model:

Exp (Exponential) or Linear

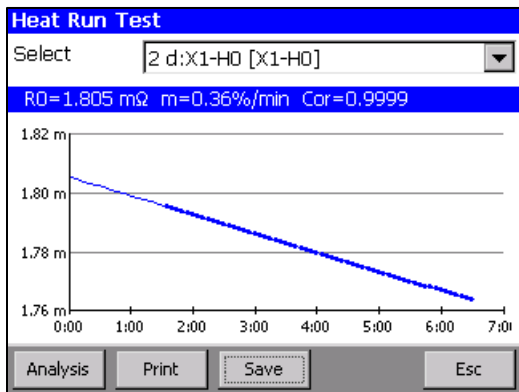

After selecting the Model press “Analyse.”

The value and the graph of the approximation $R(t=0)$ is shown.

Linear Approximation:

- R0: Winding Resistance at time $t = \text{zero}$
- m: Slew rate dr/dt in %/ min
- Cor: Correlation of the approximation

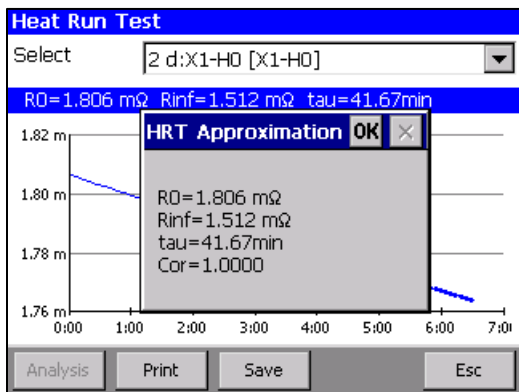

Exponential Approximation:

- R0: Winding resistance at time $t = \text{zero}$
- Rinf: Winding resistance at time $t = \infty$
- tau: Time constant
- Cor: Correlation of the approximation

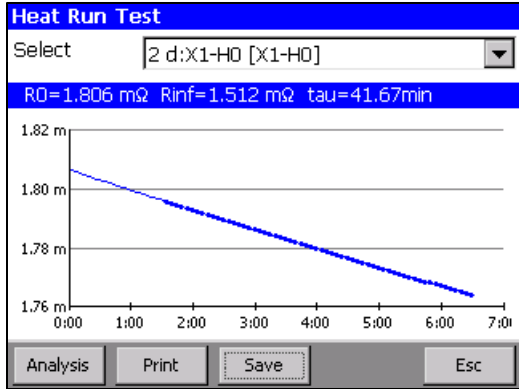

You can Print the Graph with the approximation or Save the calculated values to the corresponding results.

Save the HRT approximation

Select the "Save" button to store the calculated values and Graph as a graphical interchange format file (gif).

Time	Mode	Range	Remarks
26.10.2012 08:49	I	15	:1;R0=426.88 m[Ω];R
26.10.2012 08:49	C	15	
26.10.2012 08:49	C	15	
26.10.2012 08:49	C	15	

Details Diagram Delete Print.. Esc

The values of the corresponding measurement are stored under Remarks.

Time	Mode	Range	Remarks
26.10.	HRT Approximation		X [Ω];R
26.10.	Ch= 1		
26.10.	R0=426.88 mΩ		
26.10.	R∞=352.70 mΩ		
	T0=82.0°		
	T∞=27.0°		
	tau=41.67min		
	Cor=1.0000		
	Ch= 2		
	R0=1.805 mΩ		
	m=0.36%/min		

Details Diagram Delete Print.. Esc

Double-click on the highlighted measurement to open a new window with the calculated results.

The gif file is attached to the measurement data. If you export the data to a USB Key, the file will be located in the directory \RAYTECH\DATA\Transformername\



Showing the graph in °C

When the resistance of the winding at any specific temperature and the material is known, all the values can be displayed as °C.

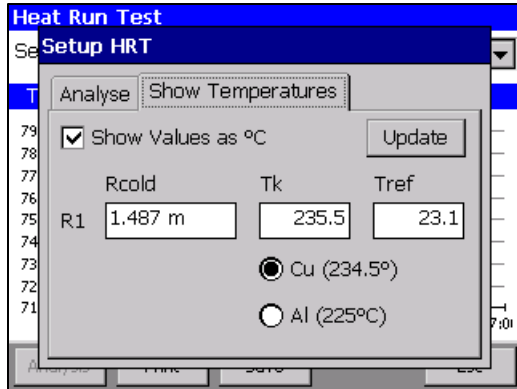

Enter the resistance value (Rcold) of the winding, the corresponding temperature (Tref) and the temperature coefficient of the conductor.

The approximation and the values are shown as Temperature.

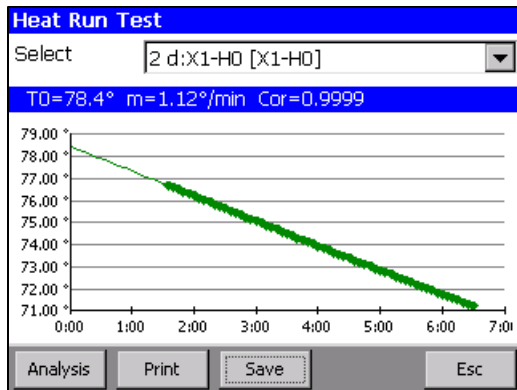

Linear Approximation:

- T0: Temperature at time t = zero
- m: Slew rate dt/dt in °/min
- Cor: Correlation of the approximation

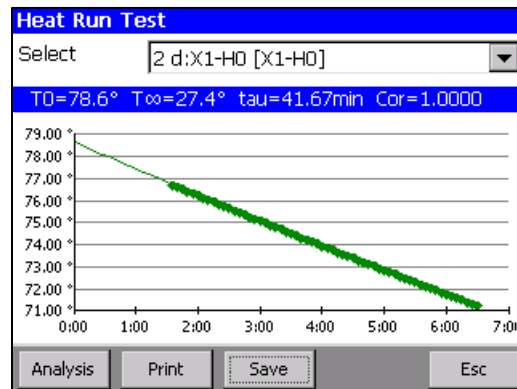

Exponential Approximation:

- T0: Temperature at time t = zero
- R∞: Temperature at time t = ∞
- tau: Time constant
- Cor: Correlation of the approximation

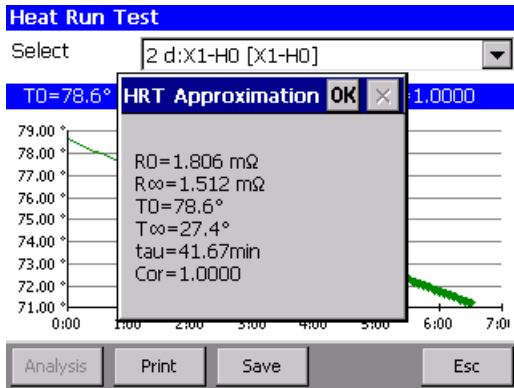

Select "Show Formula" and you will see a window after the calculation with all results.

Selecting "Show Formula" displays the calculated results.



BATTERY OPTION - WR14R¹⁶

The WR14R is available with Battery and/or Mains operation.

With the battery operating feature, the measurement will not halt if power is interrupted on the mains input. This feature is very helpful if continuous tests are being conducted. e.g. heat run tests.

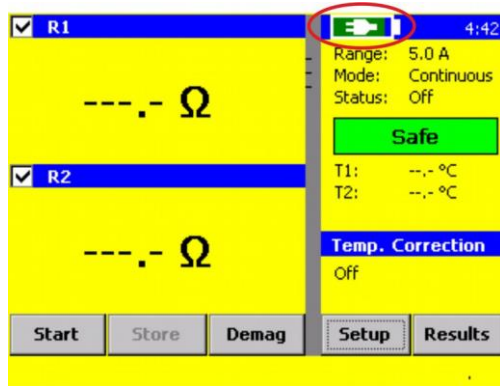

If you are using the Battery Option, there is a Battery Symbol on the top of the main screen. It indicates the Battery status and the charging condition.

With a full Battery you are able to measure 200 single measurements at 15 Amperes.

Mains supply present

A Mains (plug) connector symbol is shown inside the Battery and the green LED on the power switch is blinking. This indicates that the system is connected to the mains.

Battery charging

The area inside the Battery indicator moves from the left to the right with a blinking green LED on the Mains power switch indicating that the battery is being charged.

Charging condition

Visual indication of the area inside the Battery indicator dictates the charging condition:

If the Battery area is completely filled green, the Battery is 100% charged.

¹⁶ This Option is standard in the WR14 (field case version).

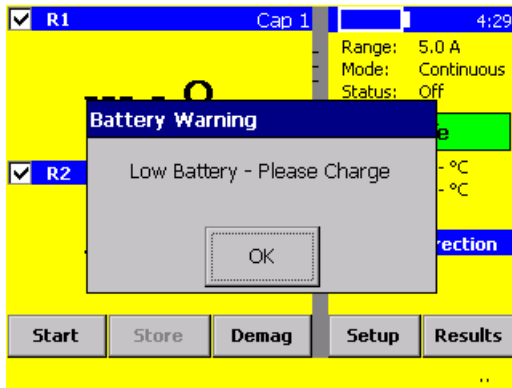

Low Battery

If the battery is low on charge, a Battery warning message will be displayed.

If conducting a measurement and this message appears, the measurement doesn't stop, but you are not able to start a new measurement until the mains supply is connected.

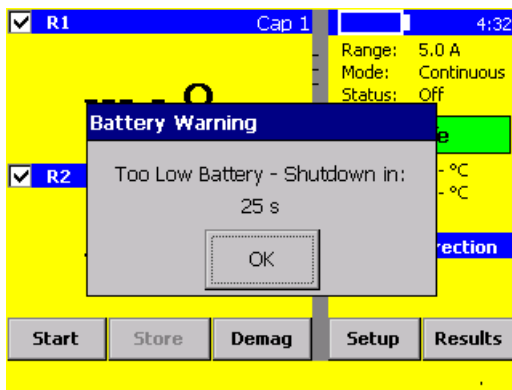

Very Low Battery

If the battery charge is extremely low, the WR14 displays a second warning message and powers down the system until a mains supply is connected.



CABLE EXTENSIONS FOR WR100R

10M CABLE EXTENSION SET FOR THE WR100-12R

The WR100-12R is available with the optional 10m cable extension sets for the Plug type cable sets (Note: Cable sets with the ring lug connectors do not have this option available). The Plug type connector locking system operates on the “push-pull” principle. It self-locks when connected. To disconnect the Plug type connector, push in first, then pull out.

Connectors that become dirty should be cleaned with industrial alcohol before connecting.

The Cable Extension Set for the WR100-12R consists of the following cables:



10M Extensions for the Current Cables (Positive and Negative)



10M Extensions for the Potential Cables (Channel 1, Positive and Negative)



10M Extensions for the Potential Cables (Channel 2, Positive and Negative)

It is possible to connect multiple 10M extensions together to increase the length.

10M CABLE EXTENSION SET FOR THE WR100-13R

The WR100-13R is available with the optional 10m cable extension sets for the Plug type cable sets (Note: Cable sets with the ring lug connectors do not have this option available). The Plug type connector locking system operates on the “push-pull” principle. It self-locks when connected. To disconnect the Plug type connector, push in first, then pull out.

Connectors that become dirty should be cleaned with industrial alcohol before connecting.

The Cable Extension Set for the WR100-13R consists of the following cables:



10M Extensions for the Current Cables (Positive and Negative)



10M Extensions for the Potential Cables (Channel 1, Positive and Negative)



10M Extensions for the Potential Cables (Channel 2, Positive and Negative)



10M Extensions for the Potential Cables (Channel 3, Positive and Negative)

It is possible to connect multiple 10M extensions together to increase the length.



CABLE EXTENSIONS FOR WR50R

10M CABLE EXTENSION SET FOR THE WR50-12R

The WR50-12R is available with the optional 10m cable extension sets for the Plug type cable sets (Note: Cable sets with the ring lug connectors do not have this option available). The Plug type connector locking system operates on the “push-pull” principle. It self-locks when connected. To disconnect the Plug type connector, push in first, then pull out.

Connectors that become dirty should be cleaned with industrial alcohol before connecting.

The Cable Extension Set for the WR50-12R consists of the following cables:



10M Extensions for the Current Cables (Positive and Negative)



10M Extensions for the Potential Cables (Channel 1, Positive and Negative)



10M Extensions for the Potential Cables (Channel 2, Positive and Negative)

It is possible to connect multiple 10M extensions together to increase the length.

10M CABLE EXTENSION SET FOR THE WR50-13R

The WR50-13R is available with the optional 10m cable extension sets for the Plug type cable sets (Note: Cable sets with the ring lug connectors do not have this option available). The Plug type connector locking system operates on the “push-pull” principle. It self-locks when connected. To disconnect the Plug type connector, push in first, then pull out.

Connectors that become dirty should be cleaned with industrial alcohol before connecting.

The Cable Extension Set for the WR50-13R consists of the following cables:



10M Extensions for the Current Cables (Positive and Negative)



10M Extensions for the Potential Cables (Channel 1, Positive and Negative)



10M Extensions for the Potential Cables (Channel 2, Positive and Negative)



10M Extensions for the Potential Cables (Channel 3, Positive and Negative)

It is possible to connect multiple 10M extensions together to increase the length.



10M CABLE EXTENSION SET FOR THE WR14-R

The WR14-R is available with the optional 10m cable extension sets instead of the 5M standard cable set.

The Cable Extension Set for the WR14-R consists of the following cables:



10M Extensions for the Current Cables (Positive and Negative)



10M Extensions for the Potential Cables (Channel 1, Positive and Negative)



10M Extensions for the Potential Cables (Channel 2, Positive and Negative)

When ordering the optional 10M Cable Extension Set with a new system, the standard 5M cable set is omitted.

TECHNICAL SPECIFICATIONS

WR50¹⁷

Type	WR50-12 / WR50-13
Size	L: 521 mm (20.5") W: 432 mm (17") H: 216 mm (8.5")
Weight	16.6 kg (36.6 lbs.)
Input Power	90-264 VAC (1.5 kW max.) 47-63 Hz, automatic ranging
Output Voltage	0 to 50V DC
Test Current	User Selectable: 0.025 50 Ampere
Panel Display	Color LCD with back lighting and touch screen
Front Panel	Sealed anodized
Interface	2 x USB 2.0 (1 host / 1 device) and 9 Pin RS 232 serial
Memory Storage	Stores up to 10,000 complete test results
Resistance Range	0.00 $\mu\Omega$ to 100 k Ω
Operating Temperature	-10°C to 60°C (14°F to 140°F)
Storage Temperature	-20°C to 70°C (-4°F to 158°F)

Current Range	Measuring Range	Accuracy	Resolution
30 - 50A	0.00 $\mu\Omega$ - 1.3 Ω	$\pm 0.1\%$ Rdg $\pm 0.05\mu\Omega$	5 Digits or 0.05 $\mu\Omega$
15 - 30A	0.0 $\mu\Omega$ - 3.3 Ω	$\pm 0.1\%$ Rdg $\pm 0.1\mu\Omega$	5 Digits or 0.1 $\mu\Omega$
8 - 15A	0.0000m Ω - 6.3 Ω	$\pm 0.1\%$ Rdg $\pm 0.2\mu\Omega$	5 Digits or 0.2 $\mu\Omega$
3 - 8A	0.0000m Ω - 16.7 Ω	$\pm 0.1\%$ Rdg $\pm 0.5\mu\Omega$	5 Digits or 0.5 $\mu\Omega$
1 - 3A	0.000m Ω - 47.2 Ω	$\pm 0.1\%$ Rdg $\pm 1\mu\Omega$	5 Digits or 1 $\mu\Omega$
0.7 - 1A	0.000m Ω - 71.4 Ω	$\pm 0.1\%$ Rdg $\pm 2\mu\Omega$	5 Digits or 2 $\mu\Omega$
0.3 - 0.7A	0.000m Ω - 167 Ω	$\pm 0.1\%$ Rdg $\pm 5\mu\Omega$	5 Digits or 5 $\mu\Omega$
0.1 - 0.3A	0.00m Ω - 500 Ω	$\pm 0.1\%$ Rdg $\pm 10\mu\Omega$	5 Digits or 10 $\mu\Omega$
25 - 100mA	0.00m Ω - 2k Ω	$\pm 0.1\%$ Rdg $\pm 20\mu\Omega$	5 Digits or 20 $\mu\Omega$
< 25mA	2k Ω - 10k Ω	$\pm 0.2\%$ Rdg $\pm 200m\Omega$	5 Digits or 200m Ω
< 25mA	10k Ω - 100k Ω	$\pm 0.8\%$ Rdg $\pm 20\Omega$	4 Digits or 20 Ω

¹⁷ Specifications are subject to improvement at any time.



Features

Pure, filtered DC power source for the highest accuracy readings
Highest Accuracy and Precision of any high current test system
Complete, automatic calibration system and system diagnostics
Automatic measurements of resistance from 0.00 $\mu\Omega$... 100 k Ω
Demagnetizing Circuit (Advanced design)
Microprocessor-based system with internal storage for over 10,000 test results
Data exchange via USB-Key or USB / RS Connection
Printing and storing of test results while the test system is measuring
Temperature channels with automatic resistance correction
Automatic, high efficiency cooling system to dissipate internal heat
Automatic shut off for over-temperature condition
Simple to operate color LCD touch screen with backlight
Panel-mounted Emergency Stop Switch
Fully automatic cooling curve analysis (option AHRT-01)
Fastest discharge time on the market
5 Year standard warranty

WR14¹⁸

Type	WR14
Size	L: 470 mm (18.5") W: 357 mm (14.1") H: 176 mm (6.9")
Weight	9.6 kg (21.1 lbs.)
Input Power	88-264 VAC, 47-63 Hz, automatic ranging
Output Voltage	0 to 30V DC
Test Current	User Selectable: 0.025 15 Ampere
Panel Display	Color LCD with back lighting and touch screen
Front Panel	Sealed anodized
Interface	2 x USB 2.0 (1 host / 1 device) and 9 Pin RS 232 serial
Memory Storage	Stores up to 10,000 complete test results
Resistance Range	0.00 $\mu\Omega$ to 100 k Ω
Operating Temperature	-10°C to 60°C (14°F to 140°F)
Storage Temperature	-20°C to 70°C (-4°F to 158°F)

Current Range	Measuring Range	Accuracy	Resolution
10 - 15A	0.00 $\mu\Omega$ - 1 Ω	$\pm 0.1\%$ Rdg $\pm 0.1\mu\Omega$	5 Digits or 0.05 $\mu\Omega$
5 - 10A	0.0 $\mu\Omega$ - 3 Ω	$\pm 0.1\%$ Rdg $\pm 0.2\mu\Omega$	5 Digits or 0.1 $\mu\Omega$
1 - 5A	0.0000m Ω - 15 Ω	$\pm 0.1\%$ Rdg $\pm 0.5\mu\Omega$	5 Digits or 0.5 $\mu\Omega$
0.5 - 1A	0.000m Ω - 30 Ω	$\pm 0.1\%$ Rdg $\pm 2\mu\Omega$	5 Digits or 1 $\mu\Omega$
0.1 - 0.5A	0.000m Ω - 300 Ω	$\pm 0.1\%$ Rdg $\pm 5\mu\Omega$	5 Digits or 2 $\mu\Omega$
25m - 0.1A	0.00m Ω - 1200 Ω	$\pm 0.1\%$ Rdg $\pm 20\mu\Omega$	5 Digits or 10 $\mu\Omega$
< 25mA	1.2k Ω - 10k Ω	$\pm 0.1\%$ Rdg $\pm 100m\Omega$	5 Digits or 200m Ω
< 25mA	10k Ω - 100k Ω	$\pm 0.5\%$ Rdg $\pm 10\Omega$	4 Digits or 20 Ω

¹⁸ Specifications are subject to improvement at any time.



Features

Pure, filtered DC power source for the highest accuracy readings

Charges inductive loads up to 1,500 Henry

Battery operated

High power DC supply (15A / 30V)

2 independent measuring channels

Automatic measurements of resistance from 0.00 $\mu\Omega$... 100 k Ω

Demagnetizing Circuit (Advanced design)

Microprocessor-based system with internal storage for over 10,000 test results

Temperature channels with automatic resistance correction

Panel-mounted Emergency Stop Switch

Fully automatic cooling curve analysis (option AHRT-01)

Fast discharge with discharge indicator – visible and audible indicator for discharge status

Simple to operate color LCD touch screen with backlight

Standard USB 2.0 & RS 232 (serial) Interface

5 Year standard warranty

INTERFACES

HARDWARE

RS 232

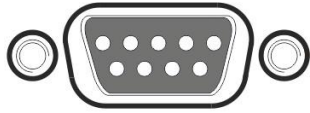

1 x RS 232, 9 Pin

RS 232

Pin 2	TxD (WR → Host)
Pin 3	RxD (Host → WR)
Pin 5	GND

Interface Parameters (fixed, unchangeable):

Port	RS 232
Baudrate	38400 Baud
Databit	8 Bit
Stopbits	1 Bit
Parity	No

USB

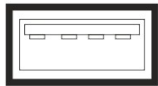

USB – Master
Standard 2.0

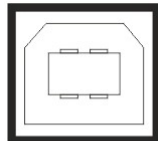

USB – Slave
Standard 2.0





EXTERN

Standard Type

The standard Type has 4 pins. You can use pin 3 and 4 to connect an external Warning Light or Beeper to indicate a dangerous condition.

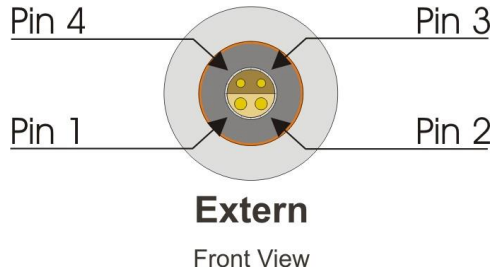

There is an internal Relay whose contact is connected to the plug “Extern.”

An external power source and a Warning Light or Beeper may be connected to pins 3 and 4 to indicate a Dangerous condition. See: Example for connecting an external warning device below.

Use the working contact between Pin 3 and Pin 4, maximum Load 240VAC 2A.



The contact is open when the system is Safe.

The contact is closed when the system is Unsafe.

Pins 1 and 2 on the Extern connector: These pins are for Raytech Service use. Do not connect anything to these pins!

Standard Type with 4 pins:



Connector in the instrument:

Lemo: ERA.1E.304.CCL
RAN: 40894



Extern:

Lemo: FFA.1E.304.CLAC60
RAN: 40895

Example for connecting an external warning device

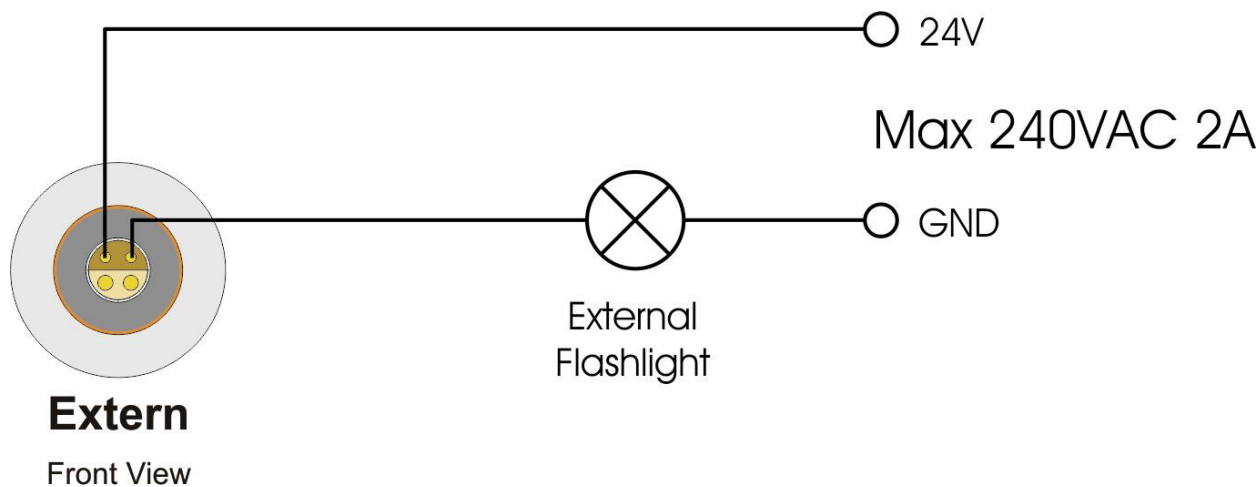

Extended Safety Circuit Type

The Extended Safety Circuit Type has 6 pins.

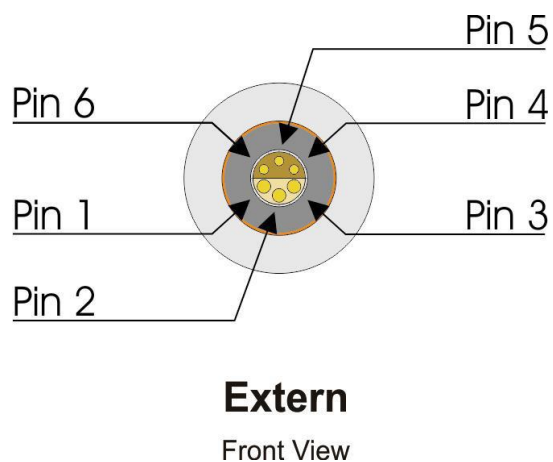

You can use pins 3 and 4 to connect an external Warning Light or Beeper to indicate a dangerous condition. The function for these pins are the same as with the standard type, see "Standard Type" on page 85.

Pins 1 and 2 on the Extern connector: These pins are for Raytech Service use. Do not connect anything to these pins!



Pin 5 and Pin 6 is part of the extended safety circuit. When these contacts are open, the instrument acts as if the emergency stop has been pressed. Pin 5 and 6 must be closed with an external switch or shorting plug.

without external safety circuit

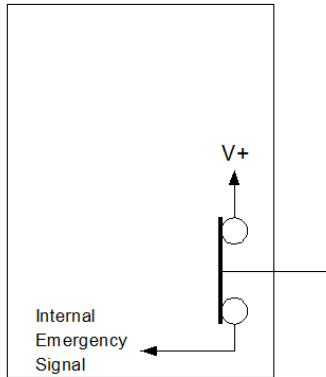

with external safety circuit

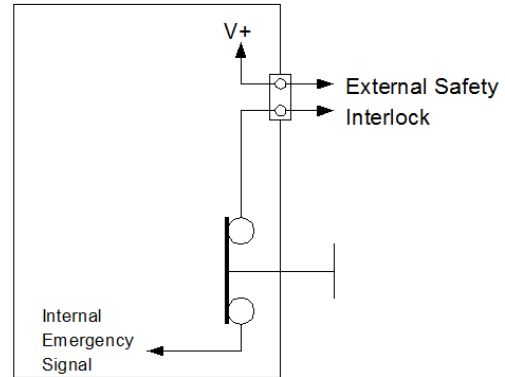

Install the shorting plug, shown here, to use the instrument without the extended safety circuit.

Pin 5 and Pin 6 are shorted together in the plug.

Extended Safety Circuit Type Connector with 6 pins:



Panelmount Connector on the instrument:

Lemo: ERA.1E.304.CCL
RAN: 40802



Cablemount Connector (Extern):

Lemo: FFA.1E.306.CLAC60
RAN: 40803

APPENDIX

MODEL: WR14 & WR50-12/13 WINDING RESISTANCE METERS



WR14: 15A WINDING RESISTANCE METER



WR50-12/13: 50A WINDING RESISTANCE METER

RAYTECH USA, INC.

118 SOUTH 2ND STREET, PERKASIE, PA 18944 USA
T: 267 404 2676 | F: 267 404 2685 | WWW.RAYTECHUSA.COM



RAYTECH T-BASE PRO

DESCRIPTION

T-Base Pro is a powerful tool to remotely control Raytech test instruments, exchange data and analyze measured data. It runs on Windows-based PC's with a modern graphical user interface which makes it easy and intuitive to operate. Any custom request or special feature can easily be added with a custom Add-On. **Visit the T-Base Pro website for more information and to download your FREE copy of the software:** <http://TBase.Raytech.ch>

Example:

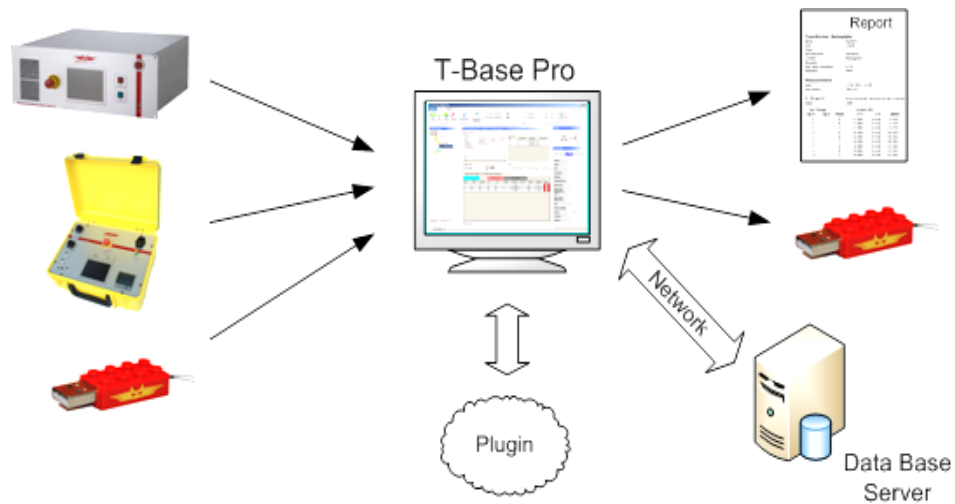

Advantages & Features:

- Import transformer name plate data and measuring results from devices by USB with a few clicks
- Generate transformer name plate data sets on your PC and export them to devices
- View measurement data in a table or diagram
- Control devices by remote (option)
- Generate, save and print test reports
- Store all your data in one database organized by transformers, not measuring method
- Use powerful search functions to find your measurements quickly
- Work with a clearly arranged user interface
- Easily integrate individual software plug-ins to expand the T-Base Pro to meet your needs.

Specifications:

Operating Sys: Min. Windows 7

Hardware: ≥ Pentium 4,
 3.2GHz,1GB Ram
 Core2 recommended

Min. Screen: 1024 x 768 pixel

Recommended: ≥ 1680 x 1050 pixel

Included:

- Native Raytech USB Driver
- Documentation

Options:

- Database located on server
- Synchronize with external server

APPLICATION EXAMPLE

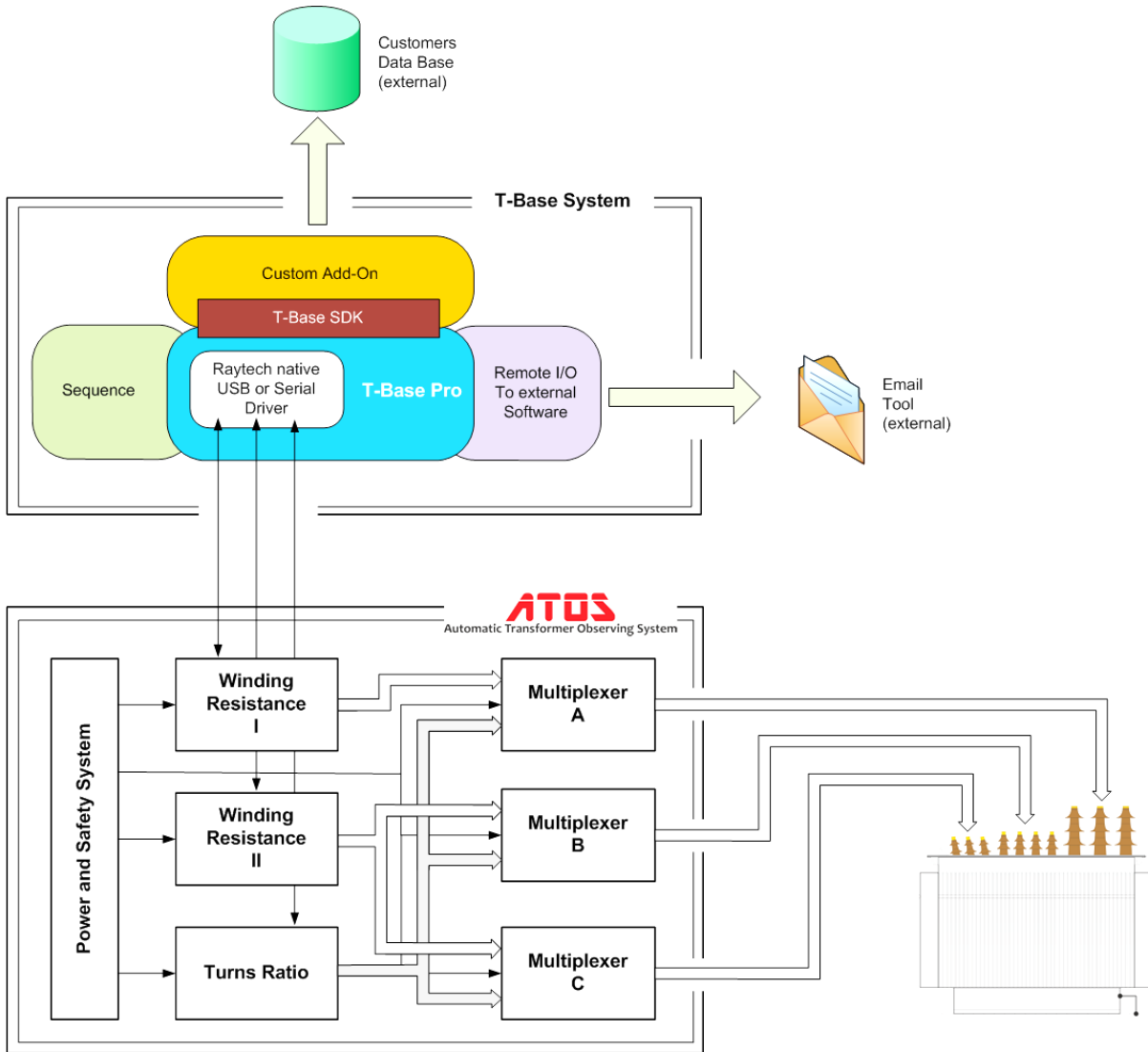

Overview

The example shows a powerful measuring system with remote control, data exchange and analysis. Pictured above is the Raytech Automatic Transformer Observing System, called **ATOS**, which is fully controlled by the T-Base Pro software. Add-Ons complete the functionality to fit into a transformer manufacturing test flow. It runs on a Windows-based PC and is operated on an easy to use graphical user interface.



Description

Raytech's Automatic Transformer Observing System, **ATOS**, combined with **T-Base Pro** software is an extremely powerful system for transformer measurements. With one cabling, all winding resistance and turns ratio measurements are done easily. Operation of the devices can be done by touch screen, or on a remote computer using **T-Base Pro**.

Compared to measurements with simple devices, measuring with an ATOS leads to drastically reduced measuring time and increased performance. Using **T-Base Pro** makes data collecting with a memory stick unnecessary.

ATOS components are connected by USB or RS 232 to your computer. The software link from devices to the operating system is done by the **Raytech Native Driver**. This software Driver is included with the T-Base Pro release.

With **T-Base Pro**, creating transformer profiles and importing and exporting of measurements are accomplished much easier than manually performing these operations.

Powerful search functions and a modern graphical user interface support users in handling transformer profiles and measurements. **Test Reports** are available in several output formats.

Complete automated transformer measurements are accomplished with the **Sequence** Add-On. All settings of Raytech devices are available by remote and can be configured individually. And any test procedure based on the available devices can be defined.

In the previous example, a **Custom Add-On** sends passed transformer measurements in the required format to the factory database. Access to any data set in this database is also provided by this Add-On. Add-Ons can be programmed by Raytech, a customer or a third party using the provided Software Development Kit (SDK).

The Raytech Add-On **Remote I/O to External Software** sends email notifications to supervisors when a transformer is tested successfully or if a failure has occurred.

CONCEPT OF T-BASE PRO

The basic T-Base Pro software is free to everyone. It consists of the Raytech native driver, internal database, possibilities to create and handle transformers and measurements and, of course, the graphical user interface.

A Software Development Kit (SDK) to create your own custom Add-On is also provided.

Proprietary Raytech Add-Ons are available as an option.

Download your FREE copy of the T-Base Pro software at: <http://TBase.Raytech.ch>

COMPONENTS OF T-BASE PRO

T-BASE PRO – TOTALLY FREE

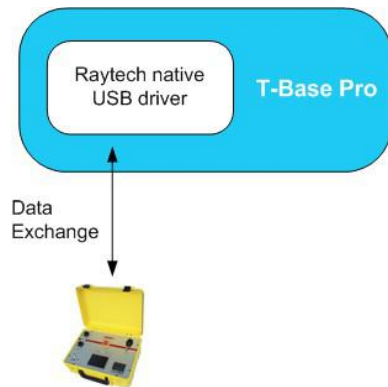

Import transformer name plate data and measuring results from devices via USB device, USB key or RS 232 with a few clicks.

Generate transformer name plate data sets on your PC and export them to devices.

View measurement data in a table or diagram.

Generate, save and print test reports.

Use powerful search functions to find your measurements quickly.

Work with a clearly arranged user interface.

CREATE YOUR ADD-ON WITH T-BASE SDK

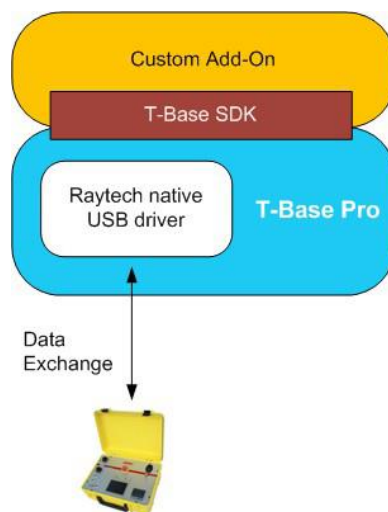

T-Base Pro is designed as an open platform. A Software Development Kit (SDK) to create custom Add-Ons easily is provided by Raytech.



T-BASE PRO REMOTE OPTION FOR RAYTECH DEVICES

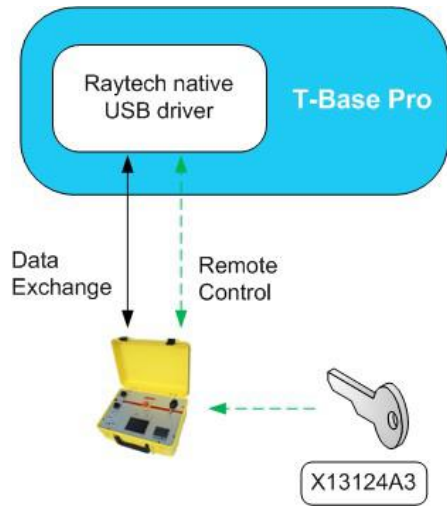

The T-Base Pro remote option for Raytech devices can be unlocked by entering a license key.

An unlocked device can be remote controlled by a graphical user interface on T-Base Pro. No additional programming is needed.

Every T-Base Pro can control several Raytech devices, as long as the license key has been entered and the devices are unlocked.

PROPRIETARY ADD-ON: SEQUENCE

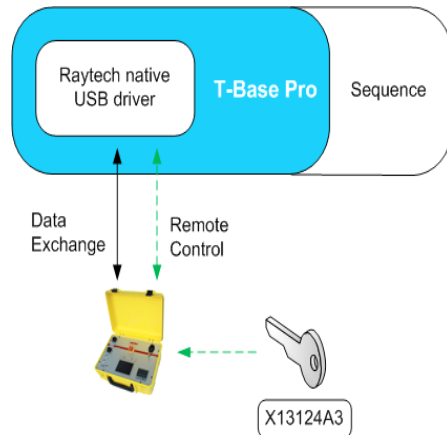

Sequence is an existing Add-On to control Raytech devices and doing complete transformer measurements in a free programmable measuring process, including winding resistance and turns ratio measurements.

Test procedures can be defined individually.

Remote Options needed for Raytech devices are included in Sequence.

PROPRIETARY ADD-ON: REMOTE I/O TO EXTERNAL SOFTWARE

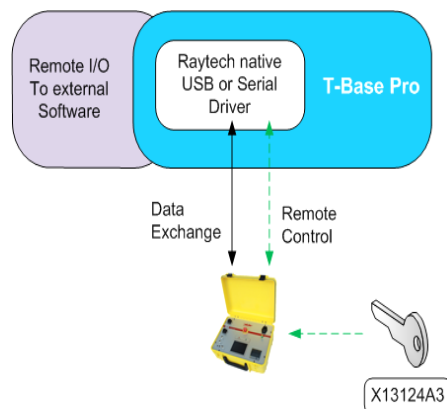

This is a basic Add-On provided by Raytech. It calls any program with a parameter on a PC. An XML file as return value is accepted.

GRAPHICAL USER INTERFACE

Raytech T-Base Pro has a modern and comfortable graphical user interface. Some of its components and basic functions are explained in the following pages.

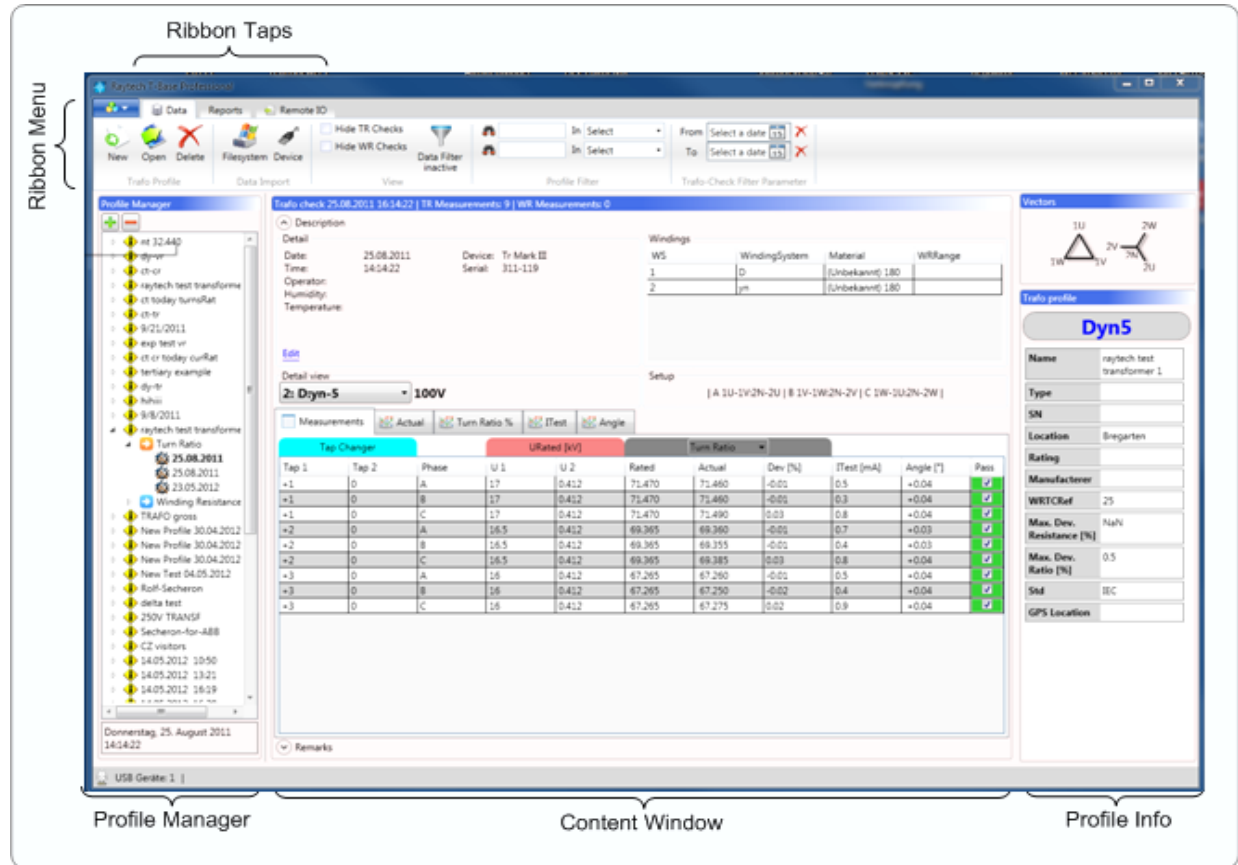

Raytech T-Base Pro is a **full, multi-tasking system**. For instance, a measurement with long duration can be started and while it is running, the user can create new profiles, exchange data with other devices, start another measurement, and so on.

Every running process will create a new **ribbon tab** in the **ribbon menu** at the top of the window.

The **profile manager** on the left side of the window shows all transformers, with measurements, stored in the database. A hierarchic illustration helps to get a quick overview.

When a profile is selected on the right border in the **profile manager**, the most important information about a transformer and its profile are displayed. The **profile info** section is a useful tool to find a required profile when browsing manually through a transformer database.

Details of selected profiles and measurements are shown in the **content window**. This section is built up dynamically and changes its content based on the selection in **profile manager**.



When remote control is chosen for a device, a new **ribbon tab** is created and automatically selected. Running processes like remote control or data exchange will not be affected. The newly created **ribbon tab** may appear differently for several Raytech devices.

The **device control** section contains all options to set up a device and do measurements. With a few clicks, a measurement is started and the results are displayed in the **results section** immediately.

Details about the device status and communication are shown in the **status** section. In the screen example below, a winding resistance meter is connected. The meter status is safe and data exchange is listed in the console.

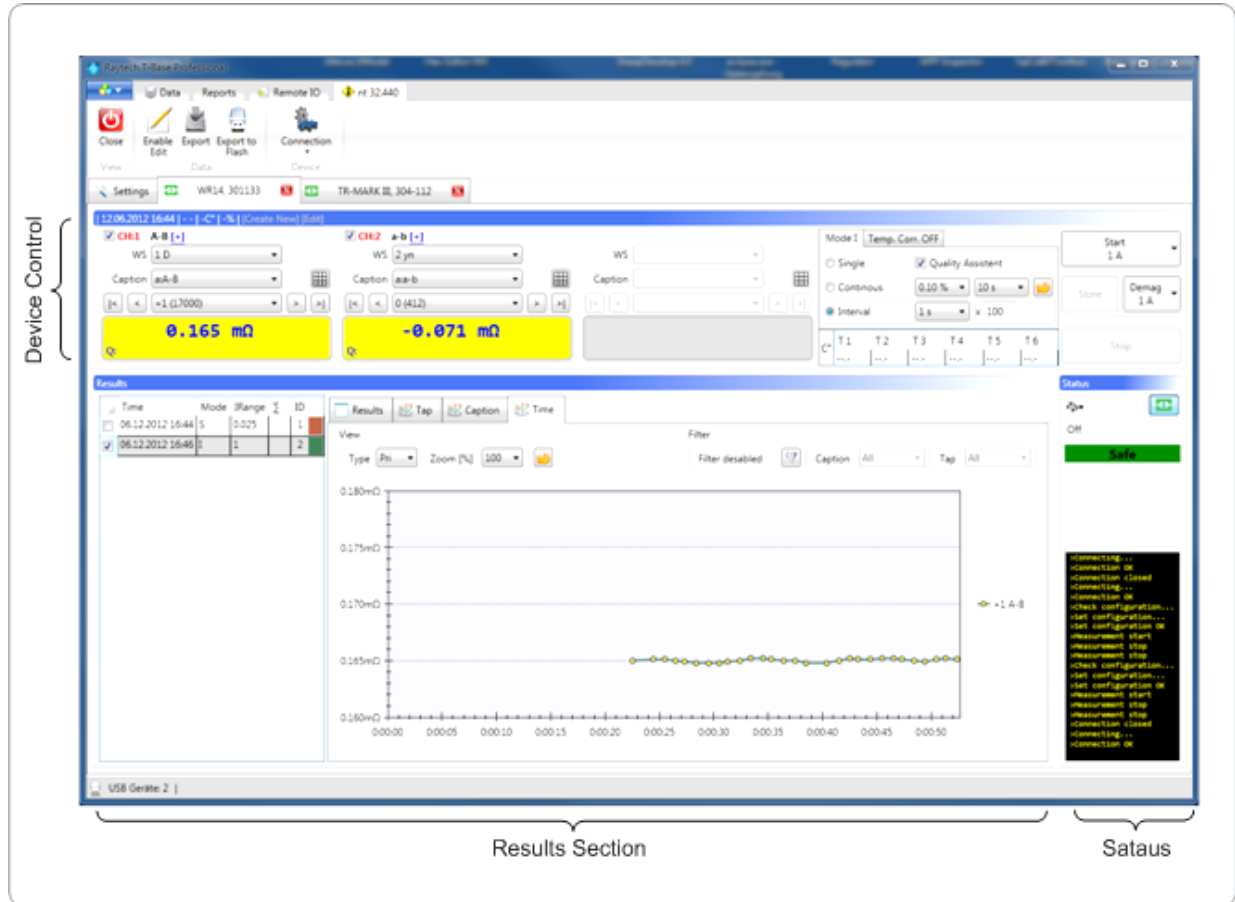

USB DRIVER FOR T-BASE PRO

The USB Drivers must be activated to allow communication between the Raytech instrument and a computer. This is accomplished by entering a simple Service Code: **2001#**

This is described further in “Raytech USB Driver for T-Base” on page 100.

SOFTWARE DEVELOPMENT KIT (SDK)

The SDK is a device management software with various possible applications. It is essentially a software layer (or driver) that resides between the Operating System (OS) IO system, custom Windows Application and Raytech instruments. The SDK with native Raytech USB Driver for Windows provides the OS with full device functionality, appearing to OS as a Raytech USB device. This software can also be used without native Raytech USB drivers to control the device over the standard RS 232 Serial port.

It is a powerful tool to write easily customized Software to control the Raytech Instruments.

For more information, download the SDK Quick Start Guide at <http://www.raytech.ch>.



SERVICE MODE

The Service Mode has limited access. There are several codes accessible for setting parameters.

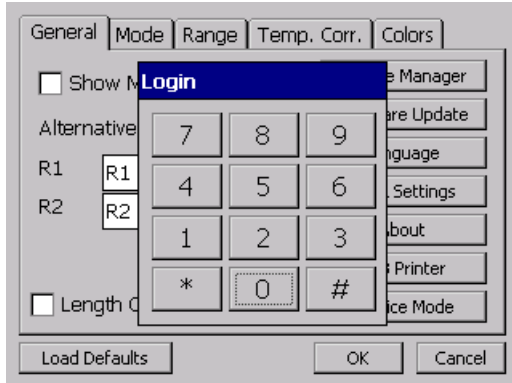

From the main screen press 'Setup'. Then in the General screen press 'Service Mode'. Enter the corresponding code or Exit by pressing '#'.
#

CALIBRATE TOUCHSCREEN

The touch screen parameters can be calibrated by the end user. Enter code **0000#** and follow the on screen instructions as depicted below.

You will see the following screen:

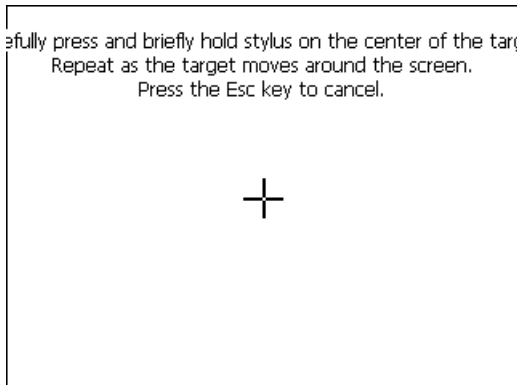

Press and hold the stylus on the center of the target until the cross moves.

Repeat as the target moves around the screen.

If a keyboard is connected, press Enter to accept the new parameters or Esc to escape.

If a keyboard is not connected, press anywhere on the screen to accept the new parameters.

SHOW GROUND WARNING¹⁹

Enable or disable a safety ground warning message when the instrument is powered on by entering the Service Code **0200#**.

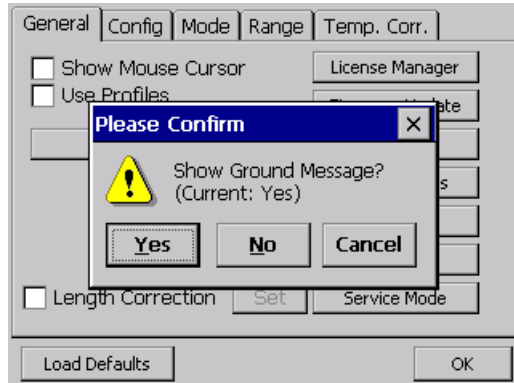

Select Yes to enable the message.

Select No to disable the message.



If the ground warning message is enabled, it will be displayed at every boot-up of the instrument and the message must be acknowledged to continue.

¹⁹ Only active in the WR14.



CSV SEPARATOR

For the export of the data to a csv file²⁰ you are able to change the separator.

You can set the CSV Separator with the following Service Codes:

- CSV Separator ';' = Code **2010#**
- CSV Separator ',' = Code **2011#**
- CSV Separator '\t' = Code **2012#**

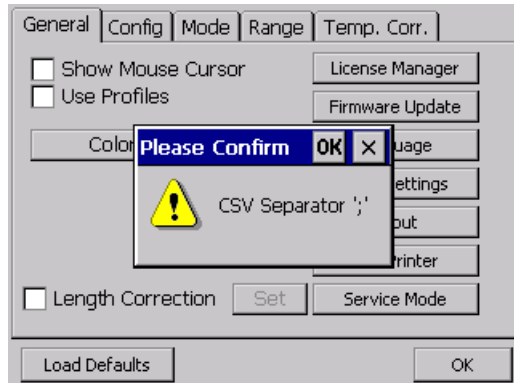

Example:

After entering the Code '2010#' in the Service Mode, the CSV Separator is ';'.

²⁰ See "Print/Export" on how to export the data to a csv file on page 55.

RAYTECH USB DRIVER FOR T-BASE

The Software Drivers must be activated to work with the powerful Software T-Base Pro (for more information see “Raytech T-Base Pro” on page 89).

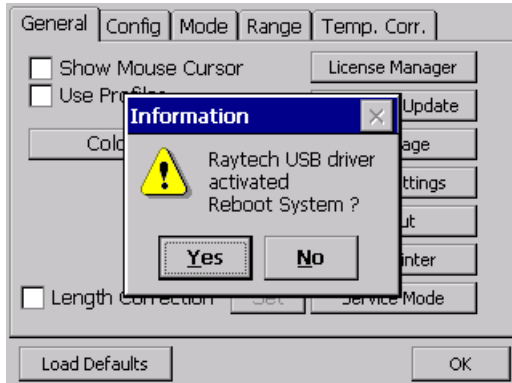

Enter the Code '**2001#**' to activate the USB Driver for the T-Base Pro.

For the changes to take effect, power down and restart the system.

ACTIVESYNC FOR TOOLBOX

Activate ActiveSync to work with the previous (older version) of Raytech Toolbox Software.

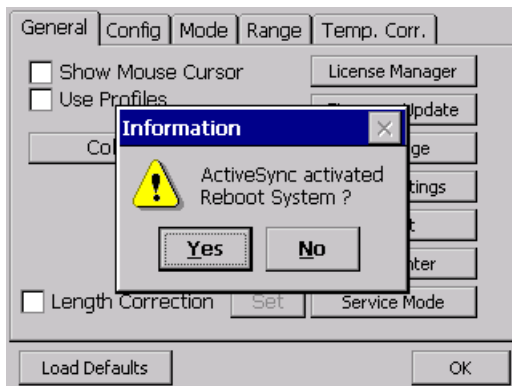

Enter the Code '**2000#**' to activate ActiveSync.

For the changes to take effect, power down and restart the system.



COMMAND SYNTAX

It is possible to control the instrument over the RS 232 or the USB port with an external computer. It is also possible to write your own test program for a full, customized test procedure.

SERIAL INTERFACE

Related Firmware 2.6.0.0 and later.

Interface Parameters

Parameter	Value
Port	RS232
Baudrate	38400 Baud
Databit	8 Bit
Stopbits	1 Bit
Parity	No
TxD (WR → Host)	Pin 2
RxD (Host → WR)	Pin 3
Gnd	Pin 7

Command Syntax

Cmd [Para[,Para2..]] LF”

Separator for Cmd and Parameters ‘ ‘ (space 0x20)

Separator for Parameters: ‘,’

Numeric Format of Numbers: float (C - Language), “.” as decimal point

Format of Strings: all ASCII Characters from 0x20 to 0xff]

Standard Response / Error Messages

“*1 Ok”l	Command successful
“*2 Syntax error”	Command unknown
“*3 Out of range”	Parameter is out of allowed range
“*4 Fail”	Command is not allowed (at this time)
“*5 Missing parameter”	Too less Parameters
“*6 Too many parameter”	Too many Parameters
“*7 Out of Range Meas”	Range change not allowed while Measuring
“*8 Internal”	Internal Error occurred

Compatibility: all commands are valid for the WR series. Examples must be adapted **to each system type**:

WR14, WR50, WR100

A description of all commands (90014 Command Set WRxx) is stored on the delivered USB-Key. The newest version can always be downloaded from the internet at <http://www.raytechusa.com>.

USB INTERFACE

Related Firmware 2.7.0.0 and later.

A description of all commands can be downloaded from the internet at <http://www.raytechusa.com>.

There you will find the USB-driver and an installation guide. The USB-driver installation is not necessary in order to use the RS 232 serial port for communication with the device.



USB PRINTER INFO

PRINTER REQUIREMENTS

Languages:

- HP PCL
- Epson ESC/P 2
- Epson Stylus COLOR
- Canon BJ (300 dpi)
- Canon BJ (360 dpi)
- Epson LX (9-pin)

DRIVER

The printer must conform to Standard USB class 7.1 device. Nearly every printer conforms as such with the exception of multifunction devices (e.g. All in One Printers).

INTERFACE

USB 2.0

SUGGESTED PRINTERS

Ink Jet:

- Canon iP90
- Epson Stylus S20
- HP-Deskjet 6940
- HP-Deskjet H470B
- HP-Deskjet H470WBT
- Epson Stylus Office B40W

Laser:

- Brother HL-5240 (Tested)
- Brother HL-2140
- Brother HL-5240L
- HP-Laserjet P1505N
- HP-Laserjet P2055DN
- HP Color Laserjet CP2025N
- PocketJet 200
- PocketJet II

The information in this document is subject to change at any time.

MEASURING HIGH- AND LOW- VOLTAGE SIDES IN SERIES

It makes sense to measure the high voltage side in series to the low voltage side to magnetize the transformer faster. Always select the 2 windings that are on the same part of the core in the same current direction. In the following table you will find examples of transformer connection schemes for injecting test current and measuring 2 windings simultaneously:

Transformer type			Current Connection			Potential Connection			
Pri.	Sec.	Vector	Current +	Jumper	Current -	Channel 1		Channel 2	
						+	-	+	-
D	d	0	H1	H3:X1	X3	H1	H3	X1	X3
			H2	H1:X2	X1	H2	H1	X2	X1
			H3	H2:X3	X2	H3	H2	X3	X2
		2	H1	H3:X1	X2	H1	H3	X1	X2
			H2	H1:X2	X3	H2	H1	X2	X3
			H3	H2:X3	X1	H3	H2	X3	X1
		4	H1	H3:X3	X2	H1	H3	X3	X2
			H2	H1:X1	X3	H2	H1	X1	X3
			H3	H2:X2	X1	H3	H2	X2	X1
		6	H1	H3:X3	X1	H1	H3	X3	X1
			H2	H1:X1	X2	H2	H1	X1	X2
			H3	H2:X2	X3	H3	H2	X2	X3
	8	H1	H3:X2	X1	H1	H3	X2	X1	
		H2	H1:X3	X2	H2	H1	X3	X2	
		H3	H2:X1	X3	H3	H2	X1	X3	
	10	H1	H3:X2	X3	H1	H3	X2	X3	
		H2	H1:X3	X1	H2	H1	X3	X1	
		H3	H2:X1	X2	H3	H2	X1	X2	
	yn	1	H1	H3:X1	X0	H1	H3	X1	X0
			H2	H1:X2	X0	H2	H1	X2	X0
			H3	H2:X3	X0	H3	H2	X3	X0
		5	H1	H3:X3	X0	H1	H3	X3	X0
			H2	H1:X1	X0	H2	H1	X1	X0
			H3	H2:X2	X0	H3	H2	X2	X0
7		H1	H3:X0	X1	H1	H3	X0	X1	
		H2	H1:X0	X2	H2	H1	X0	X2	
		H3	H2:X0	X3	H3	H2	X0	X3	
11		H1	H3:X0	X3	H1	H3	X0	X3	
		H2	H1:X0	X1	H2	H1	X0	X1	
		H3	H2:X0	X2	H3	H2	X0	X2	



D	y	1	H1	H3:X1	X3	H1	H3	X1	X3
			H2	H1:X2	X1	H2	H1	X2	X1
			H3	H2:X3	X2	H3	H2	X3	X2
		5	H1	H3:X3	X1	H1	H3	X3	X1
			H2	H1:X1	X2	H2	H1	X1	X2
			H3	H2:X2	X3	H3	H2	X2	X3
		7	H1	H3:X3	X1	H1	H3	X3	X1
			H2	H1:X1	X2	H2	H1	X1	X2
			H3	H2:X2	X3	H3	H2	X2	X3
		11	H1	H3:X1	X3	H1	H3	X1	X3
			H2	H1:X2	X1	H2	H1	X2	X1
			H3	H2:X3	X2	H3	H2	X3	X2
Yn	d	1	H1	H0:X1	X2	H1	H0	X1	X2
			H2	H0:X2	X3	H2	H0	X2	X3
			H3	H0:X3	X1	H3	H0	X3	X1
		5	H1	H0:X3	X1	H1	H0	X3	X1
			H2	H0:X1	X2	H2	H0	X1	X2
			H3	H0:X2	X3	H3	H0	X2	X3
		7	H1	H0:X2	X1	H1	H0	X2	X1
			H2	H0:X3	X2	H2	H0	X3	X2
			H3	H0:X1	X3	H3	H0	X1	X3
		11	H1	H0:X1	X3	H1	H0	X1	X3
			H2	H0:X2	X1	H2	H0	X2	X1
			H3	H0:X3	X2	H3	H0	X3	X2
	yn	0	H1	H0:X1	X0	H1	H0	X1	X0
			H2	H0:X2	X0	H2	H0	X2	X0
			H3	H0:X3	X0	H3	H0	X3	X0
		6	H1	H0:X0	X1	H1	H0	X0	X1
			H2	H0:X0	X2	H2	H0	X0	X2
			H3	H0:X0	X3	H3	H0	X0	X3
	y	0	H1	H3:X1	X3	H1	H3	X1	X3
			H2	H1:X2	X1	H2	H1	X2	X1
			H3	H2:X3	X2	H3	H2	X3	X2
		6	H1	H3:X3	X1	H1	H3	X3	X1
			H2	H1:X1	X2	H2	H1	X1	X2
			H3	H2:X2	X3	H3	H2	X2	X3

Transformer type			Current Connection			Potential Connection			
Pri.	Sec.	Vector	Current +	Jumper	Current -	Channel 1		Channel 2	
						+	-	+	-
Y	d	1	H1	H3:X1	X3	H1	H3	X1	X3
			H2	H1:X2	X1	H2	H1	X2	X1
			H3	H2:X3	X2	H3	H2	X3	X2
		5	H1	H3:X3	X2	H1	H3	X3	X2
			H2	H1:X1	X3	H2	H1	X1	X3
			H3	H2:X2	X1	H3	H2	X2	X1
		7	H1	H3:X2	X1	H1	H3	X2	X1
			H2	H1:X3	X2	H2	H1	X3	X2
			H3	H2:X1	X3	H3	H2	X1	X3
		11	H1	H3:X1	X3	H1	H3	X1	X3
			H2	H1:X2	X1	H2	H1	X2	X1
			H3	H2:X3	X2	H3	H2	X3	X2
	yn	0	H1	H3:X1	X0	H1	H3	X1	X0
			H2	H1:X2	X0	H2	H1	X2	X0
			H3	H2:X3	X0	H3	H2	X3	X0
		6	H1	H3:X0	X1	H1	H3	X0	X1
			H2	H1:X0	X2	H2	H1	X0	X2
			H3	H2:X0	X3	H3	H2	X0	X3
y	0	H1	H3:X1	X3	H1	H3	X1	X3	
		H2	H1:X2	X1	H2	H1	X2	X1	
		H3	H2:X3	X2	H3	H2	X3	X2	
	6	H1	H3:X3	X1	H1	H3	X3	X1	
		H2	H1:X1	X2	H2	H1	X1	X2	
		H3	H2:X2	X3	H3	H2	X2	X3	
S	s	0	H1	H0:X1	X0	H1	H0	X1	X0
		6	H1	H0:X0	X1	H1	H0	X0	X1

The table is the ANSI standard. You can change it, e.g. to the IEC standard, by substituting:

- H1 to 1U
- H2 to 1V
- H3 to 1W...



MEASURING WITH 2 WR METERS AT THE SAME TIME

It is possible to measure the high and the low voltage side of a transformer at the same time using 2 Winding Resistance Meters. This makes sense if you want to have two different test currents at the same time between the high and the low voltage side during a Heat Run Test.

The following points must be considered for this test application:



NOTE!

Always use the 2 windings on the same core and connect them in the same current direction. To find out the corresponding windings of a transformer, you can use the table from the previous chapter, Measuring High- and Low-Voltage-side in Series on page 104.



START MEASUREMENT!

Start the measurement on the high voltage side first. When the current is flowing on the high voltage side, press “Start” on the instrument which is connected on the low voltage side.



STOP MEASUREMENT!

Upon obtaining the test results, first stop the current on the low voltage, then stop the current on the high voltage side.

Example:

The following is an example of a transformer prepared for a Heat Run testing, utilizing a WR-14 and a WR50, having the following nameplate:

HV: 66KV, 78.8A

LV: 11KV, 473A

At the moment, the source providing power to heat the transformer should be switched off. Press the Timer on both Winding Resistance meters. This will set the base start time. Connect the measuring cables from the WR14 to the high voltage side of the transformer and connect the measuring cables from the WR50 to the corresponding²¹ winding of the low voltage side.

Start the measurement on the high voltage side first with the WR14 set to "interval mode" with a Current of 7A²²

After the current is flowing on the high voltage side, Start the measurement on the low voltage side with the WR50 set to "interval mode" with a current of 40A.

After the results are obtained, stop the current on the low voltage side first (WR50) and then stop the current on the high voltage side (WR14).

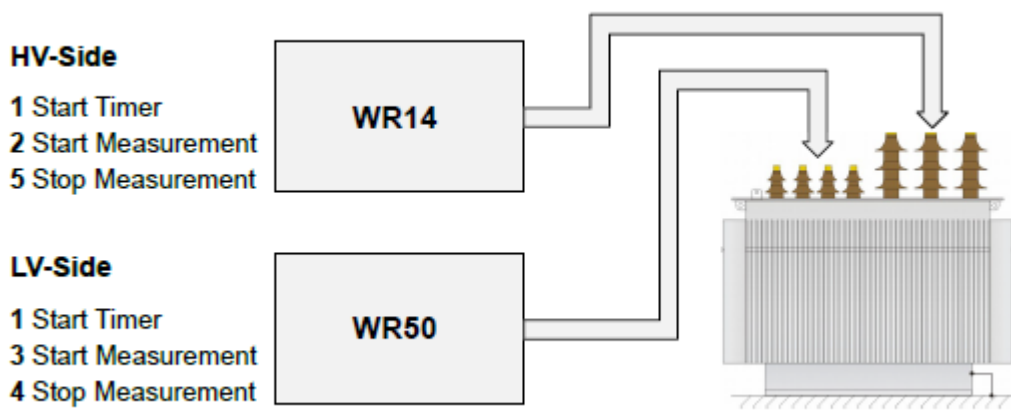

Now you can analyze the test results with the optional heat run test software to calculate the cooling curve. A description of this software can be found in "Heat Run Test Software" on page 65. Or you may export the results on a computer and analyze the data with our Software "T-Base Pro".

²¹ See the previous chapter, "Measuring High- and Low-Voltage-Side in Series" on page 104.

²² Ensure that the test current does not exceed 10% of the rated winding current; this could cause erroneous reading due to heating in the windings.



DEMAGNETIZING

ENERGIZING MAGNETIZED TRANSFORMERS

Problems can be created when the core of a transformer becomes magnetized prior to being energized for use. Damage to the insulation and deformation of the windings are two of the most common side effects.

Generally, Transformer cores, during operation are magnetized, demagnetized and then magnetized and demagnetized in the opposite direction for each sine wave cycle.

It is not easy to determine the magnitude the core is magnetized at the moment the Alternating Current source is switched off. The larger the hysteresis of the iron in the core material, the greater the magnetization level. The magnitude of magnetization depends upon the moment the transformer is switched off and the applied voltage level during the power on state.

The highest magnetization in this scenario occurs when a transformer is switched off right at the moment the voltage source sine wave crosses the zero-line.

Transformer cores are also magnetized after having a Direct Current source flow in a winding. For example, the application of Direct Current when performing a Winding Resistance test. After measuring the Winding Resistance, the core is magnetized to its maximum hysteresis.

Both of these scenarios can leave the core in an unpredictable state which can cause damage when energized. These problems can be eliminated if the transformer is demagnetized prior to being energized for use.

CONCLUSION

- A transformer is magnetized when power is switched off. Even if a transformer is completely de-energized, it can still be in a magnetized state!
- After performing DC tests on a transformer winding, the core is magnetized.

CONSEQUENCES OF ENERGIZING A MAGNETIZED TRANSFORMER

When a magnetized transformer is switched back on line, it is quite possible, depending upon the position of the sine wave and other variables, that inrush current can exceed 8 times the nominal current flow. This hazardous situation may cause tripping of over-current relays, damage to the insulation medium and deformation of the transformer windings.

PROCEDURE FOR ELIMINATING THE MAGNETIZED STATE OF A TRANSFORMER

One option to safely re-energize a transformer back on line and avoid a dangerous and damaging situation is to apply an AC voltage source and increase the voltage level to the operating voltage level then decrease the voltage level to zero. Under controlled conditions this is possible. However, this undertaking may not be theoretically possible when energizing a transformer on site. Equipment required to fully demagnetize a transformer in this manner is large and expensive.

A better solution is the Raytech Winding Resistance Meter, WR-Series.

These easy-to-use systems are recognized throughout the world for precision winding resistance measurements. A unique and new feature built into the WR-series is the ability to automatically demagnetize a transformer core on site.

Avoid unnecessary damage and unsafe conditions when energizing a transformer; use one of the Raytech WR-series instruments.

PARAMETERS FOR DEMAGNETIZING

The WR series utilizes the reverse Current reduction method with additional techniques to Demagnetize a transformer.

The WR series test systems have different levels for the Demagnetization of Windings: Fast, Course, Medium, Fine and Superfine.

Fast: Basic Demagnetization cycle. Selected to just quickly remove residual magnetization.

Course: Reduced Demagnetization cycle. Normally selected if the transformer is to be re-energized.

Medium: Average number of Demagnetization cycles. Selected if further testing is to be done.

Fine: High number of Demagnetization cycles. Selected if Medium Demagnetization cycle mode did not fully De-magnetize the transformer. This mode takes several minutes to complete.

Superfine: Ultra High number of Demagnetization cycles. Selected if Fine Demagnetization cycle mode did not fully De-magnetize the transformer. This mode takes the longest to complete.

Note: Running a Demagnetization mode twice can be helpful. For example, running Medium twice can be as effective as running the longer interval Fine mode; the advantage could be reduced time.

The optimal Demagnetizing Current selected is the same as the Measuring Current used during the Winding Resistance measurement or the maximum allowed for the nominal Current level of the High Voltage Winding.

The Current of the WR series test system should be applied on the High Inductive or High Voltage side of the transformer with the Potential cables from Channel 1 also connected.

For Delta Wound High Voltage Windings: Connect the Current Leads and Channel 1 Potential Leads to the Center Phase or Limb on the High Voltage side.

For Wye Wound High Voltage Windings: Connect the Current Leads and Channel 1 Potential Leads then short two of the Phases. For example: For example place a short between H1 and H2. Place +Current lead on H1 and -Current lead on H3. Channel +1 on H1 and Channel -1 on H3.

Note: Do not run Demagnetization mode from a single phase to Neutral on a Wye winding.

Summary:

Demagnetize on the Primary or High Voltage side.

Delta wound: Use the center phase to demagnetize

Wye wound: Short two of the phases. For example place a short between H1 and H2. Place +Current lead on H1 and -Current lead on H3. Channel +1 on H1 and Channel -1 on H3.

Note: Do not run Demagnetization mode from a single phase to Neutral on a Wye winding.



MULTIPLEXER

Description

Raytech Multiplexer is designed to drastically reduce cabling time and increase test performance. It is made to be used with Raytech Winding Resistance and Turns Ratio Meters. Any Multiplexer configuration can be easily controlled by a Winding Resistance Meters touch panel or by remote.

Example:

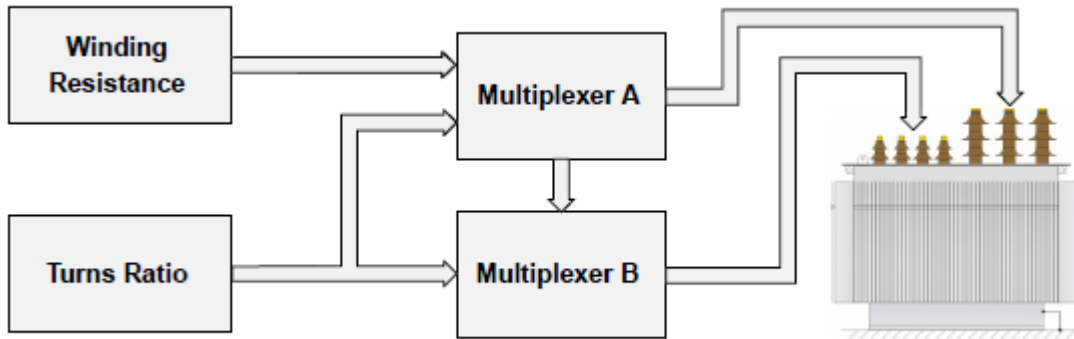

Advantages & Features:

- Minimizes cabling time.
- Does all measurements with one cabling per transformer, including Winding Resistance and Turns Ratio.
- Uses up to three Multiplexers and measure transformers with three winding systems with one cabling sequence.
- Many configurations are possible containing up to three Multiplexers, up to three Winding Resistance Meters and a Turns Ratio Meter.
- Control your Tap Changer with a powerful tap changer interface.
- Operate all instruments on a touch screen or by remote control.
- Get a customized, complete solution containing WR, TR, and Multiplexers. Ask Raytech for the ATOS (Automatic Transformer Observation System).

Specifications:

- Power Supply: 100 ... 240 VAC
- Case: 19" Rack 4U
- Interface: Raytech Serial Intercom

Included in Delivery:

- 10M standard cable sets to test object
- Standard cables to WR and TR
- Firmware update for WR14/50/100

Options:

- Cable set for 2 or 3 Multiplexer systems
- Integrated Safety Unit providing fused electrical power, central interlock system and central warning lamp interface.

ERROR MESSAGES

Raytech instruments are designed to be precise, rugged and trouble free. In most cases, many operators will never see any error messages.

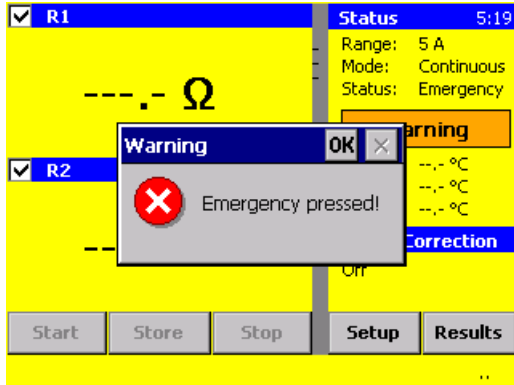

The emergency switch is activated²³.

In this condition it is not possible to start a measurement.

Exit this message screen by touching "OK."

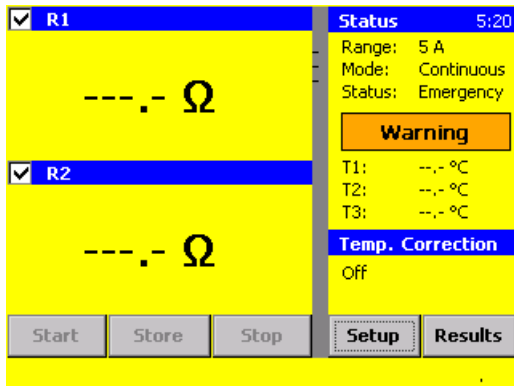

The system will revert to a pretest or main screen similar to the one shown.

Because the emergency switch is still depressed, you are not able to start a new measurement.

All other features of the system such as storing, printing are still active.



Turn the Emergency Stop button clockwise to release.

²³ In case of Interlock-Modification for extend safety circuit the same message appears. For more information, see "Extended Safety Circuit Type" on Page 86.

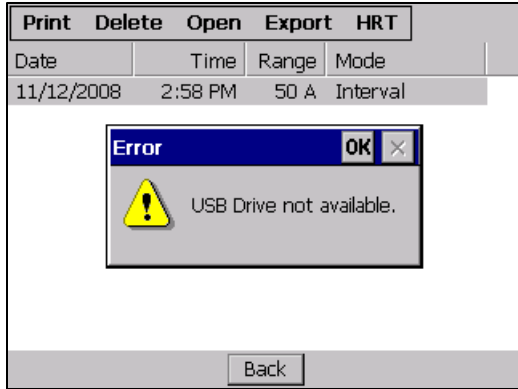

Attempting to store results to the USB key without any device key (USB key) plugged into the WR-instrument USB port.

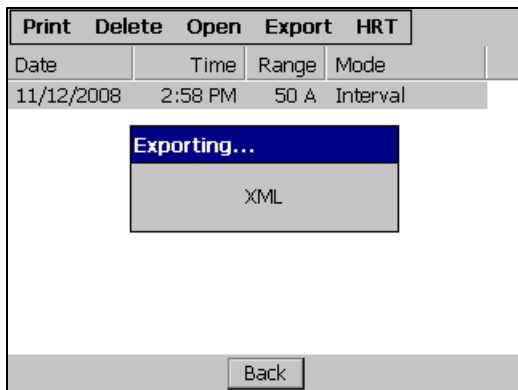

Plug the USB key in and try again. The following will appear. The data can then be exported.

TROUBLE SHOOTING

When all WR series instruments are powered on, an internal calibration and check sequence is performed.

Upon completion of the check sequence, the test set will proceed to the “Main Screen.”

Should there be any problem detected with the test set, an error message will appear.

System does not display anything:

1. Check the display for any Initialization.
2. Check the fuses. The fuses are located on the rear or the front panel of the instruments.

Touch Panel does not work:

Connect a USB mouse to the USB port and control the instrument with it. The instrument will automatically display a cursor and everything can be done by mouse. See “Mouse Cursor” on page 34.

Try to recalibrate the touch panel: See “Calibrate Touchscreen” on page 97.

USB Memory Stick does not work:

There are a few unsupported memory sticks available on the market. Please use another model or brand and try again.

Test Current cannot be turned on:

Is the Emergency Stop switch pushed in? Turn it clockwise to release.



Erratic or erroneous readings:

Possible causes:

1. Test lead damaged or not connected.
2. Poor test lead connection.
3. Poor Mains power source supply. Check extension cords, plugs and cables carefully.
4. Test set attached to a "Live" load or high interference load.
5. Trying to measure the primary winding in series to the secondary winding. See "Measuring High- and Low-Voltage-Side in Series" on pages 104.

Cannot switch off the WR14:

Disconnect the power cable and press the Power switch for 15 seconds.



NOTE!

The WR series instruments are designed to be trouble free. If problems or questions do arise, please contact your nearest Representative or our Service Support Group:

118 S. 2nd Street
Perkasie, PA 18944, USA
T: 267 404 2676
Service@Raytechusa.com

WARRANTY CONDITIONS

Raytech USA, Inc. warrants to the original purchaser that its products shall be free from defects in material and workmanship under normal use and service for a period of 60 months from the original date of shipment. An additional extended warranty period is provided, at cost to the end user, for the products covered under this warranty if the products are returned on each calendar year from the original date of shipment, prepaid, to Raytech USA, for system evaluation.

The obligation of Raytech USA, Inc. under this warranty is limited, in its exclusive option, to repair, replace, or issue credit for parts or materials which prove to be defective, and is subject to purchaser's compliance with the Raytech USA, Inc. warranty claim procedure as set forth within this manual. Raytech USA, Inc. shall at their option and expense, repair or replace any part or parts that prove to be defective within the warranty limitation period irrespective of the operating time of the test equipment, provided that the cause of the defect occurred prior to the time at which the risk was passed. The purchaser is obligated to immediately notify Raytech USA, Inc. in writing of any defects of the supplied test equipment. Raytech USA, Inc. must always be given the opportunity to rectify a defect within a reasonable amount of time. The purchaser shall grant adequate amount of time that the test equipment shall be repaired.

This warranty covers only those parts and/or materials deemed to be defective resulting from manufacturer's workmanship. The liability of Raytech USA, Inc. shall be limited to the repair, replacement, or issuance of credit for parts deemed defective within the meaning of this warranty. Costs for all transportation, labor or other expenses that may have occurred incidental to the inspection, repair, replacement, or issuance of credit for such parts and/or materials shall be the sole responsibility of purchaser. This warranty shall not apply to any accessories, parts, or materials not manufactured or supplied by Raytech USA, Inc.

Equipment must be returned, prepaid, with a Return Material Authorization (RMA) to:

Raytech USA, Inc.
118 S. 2nd Street
Perkasie, PA 18944 USA
Tel. + 267 404 2676
Fax. + 267 404 2685
www.RaytechUSA.com



LIMITATION OF WARRANTY

The foregoing warranty shall not apply to any or all of the following circumstances:

- Defects resulting from improper and unauthorized modifications or misuse and abuse of the product, negligence, alteration, modification, faulty installation by the customer, customer's agents or employees,
- Attempted or actual dismantling, disassembling, service or repair by any person, firm, or corporation not specifically authorized in writing by Raytech USA,
- Defects caused by or due to handling by carrier, or incurred during shipment, trans-shipment, or other move, and/or
- Inadequate maintenance by the customer, second source supplied software or interfacing, operation outside the environmental limits, or improper site preparation.

Exclusive remedies provided herein are the customer's sole and exclusive remedies. Raytech USA, Inc. shall not be liable for any damages resulting from the use of this equipment whether direct, indirect, special, incidental, or consequential damages, or whether based on contract, tort, or any other legal theory.



NOTE!

No other warranty is expressed or implied.

ARBITRATION

All disputes arising out of or in connection with the warranty agreement between the purchaser and Raytech USA, Inc., and including those regarding the legal validity of the warranty and this arbitration clause, shall be settled out of court and may be referred to arbitration for final decision.

Any disputes between the purchaser and Raytech USA, Inc. shall be settled according to the rules of settlement and arbitration of the chamber of commerce in Pennsylvania by one or more arbitrators appointed also according to the rules of arbitration of the chamber of commerce in Pennsylvania.

CONTACT INFORMATION:

Raytech USA

Raytech USA
118 S. 2nd Street
Perkasie, PA 18944

Phone: +267 404 2676

Fax: +267 404 2685

Email: Sales@RaytechUSA.com

Website: <http://www.RaytechUSA.com>

Your Local Representative